

ELECTROMECHANICAL ACTUATORS

Flexibility and High Performances

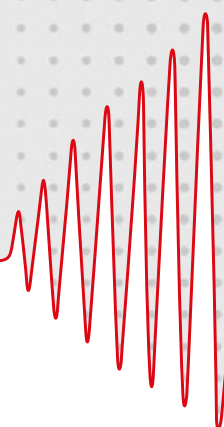

www.step-lab.com



STEP Lab is specialized in the production of electrically operated mechanical testing machines for static and dynamic tests.

STEP Lab è specializzata nella realizzazione di macchine per test meccanici ad azionamento elettrico per prove statiche e dinamiche.

STEP Lab offers a complete range of solutions for mechanical testing of products and materials. STEP Lab's technical skills in the field of data acquisition and high-performance controls are offered to satisfy the different test requirements even the custom ones.

STEP Lab has been manufacturing electromechanical actuators for static and dynamic applications for many years and has dedicated its work to applications where reliability and precision are required.

STEP Lab offre una gamma completa di soluzioni per i test meccanici di prodotti e materiali. Le competenze tecniche di STEP Lab nel settore dell'acquisizione dati e dei controlli ad alte prestazioni sono a disposizione del cliente per soddisfare anche le esigenze di test custom.

STEP Lab realizza da molti anni attuatori elettromeccanici per applicazioni statiche e dinamiche dedicate ad applicazioni dove viene richiesta affidabilità e precisione.

INDEX INDICE

GENERAL INFO

INFORMAZIONI GENERALI

Pag. 4



INTEGRATION with TEST CENTER SOFTWARE

INTEGRAZIONE con TEST CENTER SOFTWARE

Pag. 8



EA02

Pag. 10



EA05

Pag. 14



EA015

Pag. 21



EA050

Pag.26



EA100

Pag. 32



EA200

Pag. 35



BI-AXIAL VARIANT:TORSIONAL ACTUATOR

VARIANTE BI-ASSIALE: ATTUATORE TORSIONALE

Pag. 38



TYPES OF STRUCTURE

TIPI DI STRUTTURA

Pag. 39

➤ About STEP Lab

STEP Lab is your global partner for product and material testing systems.

Step Lab specializes in electrical systems to be used in areas that until now had been reserved for hydraulic systems.

Today STEP Lab is able to offer the widest range of electric actuators on the market. These systems are completed by an electronic and software platform that allows you to manage any type of test both on single or multiple actuators.

STEP Lab proposes itself as the main partner in the realization of testing systems. STEP Lab directly develops, produces and sells all the accessories necessary to satisfy the customer's needs.

- ➔ Structures for loads from 1 kN up to 265 kN
- ➔ Climatic chambers is equipped with refrigerant circuit with a temperature range from -70 to + 250 °C
- ➔ Grips
- ➔ Torsional actuators

STEP Lab è il vostro partner globale nella realizzazione di sistemi di prova per prodotti e materiali.

STEP Lab è specializzato in sistemi elettrici da impiegare in ambiti che fino ad oggi erano stati riservati a sistemi idraulici.

Oggi STEP Lab è in grado di proporre la più ampia gamma di attuatori elettrici sul mercato. Questi sistemi sono completati da una piattaforma elettronica e software che permette di gestire qualunque tipologia di prova sia su attuatori singoli o multipli.

STEP Lab si propone come partner principale nella realizzazione dei sistemi di prova e per questo sviluppa e produce e commercializza direttamente tutti gli accessori necessari a soddisfare le esigenze del cliente.

- ➔ Strutture per carichi da 1 a 265 kN
- ➔ Camere climatiche dotate di circuito frigorifero con range di temperatura da -70 a +250°C
- ➔ Griffe
- ➔ Attuatori torsionali

➤ Electro-mechanical Actuators / Attuatori Elettromeccanici

STEP Lab presents the new series of EA electromechanical actuators, the result of 10 years of experience in the global market and technological challenges in the field of dynamic applications.

The EA series was created to meet the needs of dynamic applications even in cyclic applications with a high number of cycles and short stroke.

The actuators have been designed to operate both alone on structures and on production lines for quality control.

Compared to the previous series STEP Lab has significantly reduced weights and dimensions but, at the same time, has expanded the Dynamic load range up to 200kN.

To accompany the birth of this important product range, this technical catalog has been prepared. This catalog has the function of guiding the customer in choosing the right product for his needs. STEP Lab will propose a series of standard configurations created to cover the most common needs of the market both in the testing and industrial fields.

STEP Lab presenta la nuova serie di attuatori elettromeccanici EA frutto dell'esperienza di 10 anni nel mercato globale e sfide tecnologiche nell'ambito delle applicazioni dinamiche.

La serie EA nasce per soddisfare le esigenze delle applicazioni dinamiche anche in applicazioni cicliche con elevato numero di cicli e corsa breve.

Gli attuatori sono stati concepiti per operare sia da soli su strutture sia su linee produttive per il controllo qualità.

Rispetto alla serie precedente sono stati diminuiti significativamente pesi ed ingombri e contestualmente è stata ampliata la gamma. I carichi dinamici arrivano fino a 200 kN

Per accompagnare la nascita di questa importante gamma di prodotto è stato preparato questo catalogo tecnico che ha la funzione di guidare il cliente nella scelta del prodotto più giusto per le sue esigenze. A tal fine STEP Lab proporrà una serie di configurazioni standard create per coprire le più comuni necessità del mercato sia in ambito testing che industriali.

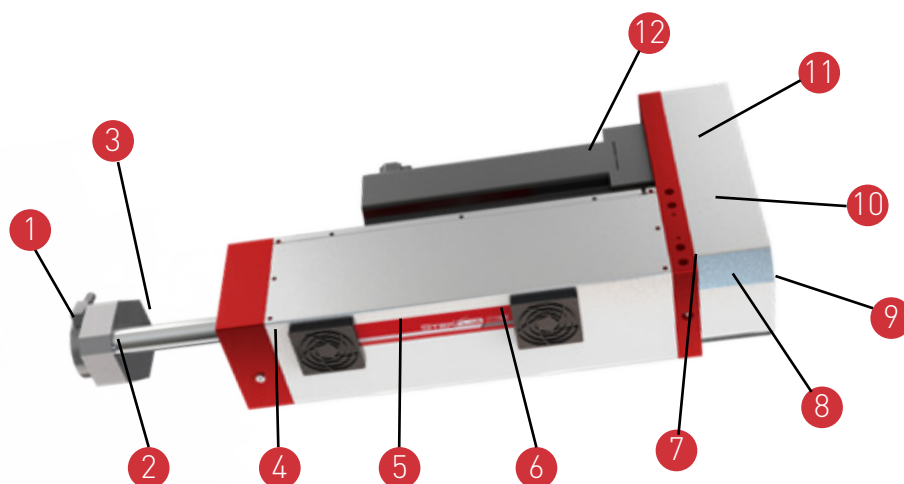

General Description

The EA series is not only a electromechanical actuators but real electrical machines able to carry out any type of application where high performance is required.

The EA series compared to the main competitors is born with unique intrinsic characteristics:

- 1 Connection with a precision centering and a preload pin
- 2 Hardened and anti-corrosion rod
- 3 Rod guide based on ball recirculation systems
- 4 Liquid / air cooling screw systems
- 5 Anti-rotation system based on recirculating ball guides to withstand both side and torsional loads
- 6 Special screws dedicated to long term cyclic applications
- 7 Special bearings dedicated to long term cyclic applications
- 8 Lubrification point with special greases for long maintenance intervals
- 9 Special belts to eliminate effects of hysteresis
- 10 Posterear anchor points for application flexibility
- 11 Special system for precise and repeatable positioning of the belt and for supporting the lateral load of the belt
- 12 Highly dynamic motors with absolute encoder and electromagnetic safety brake

Descrizione generale

La serie EA non sono semplici attuatori elettromeccanici ma vere e proprie macchine elettriche per effettuare qualunque tipo di applicazione dove siano richieste prestazioni elevate.

La serie EA rispetto ai principali concorrenti nasce con caratteristiche intrinseche uniche:

- 1 *Collegamento con centraggio di precisione e pin di precarico*
- 2 *Stelo temprato e anti corrosione*
- 3 *Guida stelo basata su sistemi a ricircolo di sfera*
- 4 *Sistemi di viti a ricircolo raffreddati ad liquido/aria*
- 5 *Sistema anti rotazione basato su guide a ricircolo di sfere per sopportare sia carichi laterali che torsionali*
- 6 *Viti speciali dedicate ad applicazioni cicliche a lunga durata*
- 7 *Cuscinetti speciali dedicati alle applicazioni cicliche a lunga durata*
- 8 *Punto di lubrificazione con impiego di grassi speciali per lunghi intervalli di manutenzione*
- 9 *Cinghie speciali per eliminare giochi e effetti di isteresi*
- 10 *Punti di ancoraggio posteriori per flessibilità di applicazione*
- 11 *Sistema speciale per un posizionamento preciso e ripetibile della chinghia e per il supporto del carico laterale della chinghia*
- 12 *Motori ad alta dinamica con encoder assoluto e freno elettromagnetico di sicurezza*

➤ Applications / Applicazioni

The EA series actuators are specifically developed for applications in the testing field (both materials and products) and in the industrial field and in general in all those applications where performance with high reliability and precision are required.

➔ Material testing laboratories: used together with our standard structures, the controller and the Test Center software, highly reliable and flexible test machines are created, perfect for testing all types of materials to characterize them from a static and dynamic point of view.

➔ Product test laboratories and quality certification laboratories: used together with the controller and the Test Center software, they can be mounted alone or together with other actuators on structures built by STEP Lab or directly by the customer to carry out even complex tests on products.

➔ In the production line to carry out pressings or to carry out quality checks: thanks to the combination of sophisticated control, software dedicated to quality control and high precision mechanical components, the actuators are perfect for carrying out repeated tests for large numbers of cycles even in the case of applications H24.

Gli attuatori della serie EA sono specificatamente sviluppati per applicazioni in ambito testing (sia materiali che prodotto) che in ambito industriale ed in generale in tutte quelle applicazioni dove siano richieste prestazioni con affidabilità e precisione elevata.

➔ Laboratori di test materiali: impiegati insieme alle nostre strutture standard, al controllore e il software Test Center si realizzano macchine di prova ad altissima affidabilità e flessibilità perfette per testare tutte le tipologie di materiali per caratterizzarli dal punto di vista statico e dinamico.

➔ Laboratori di test prodotto, laboratori di certificazione qualità: impiegati insieme al controllore e software Test Center possono essere montati da soli o insieme ad altri attuatori su strutture realizzate da STEP Lab o direttamente dal cliente per realizzare test, anche complessi, su prodotti.

➔ In linea di produzione per effettuare piantaggi o per effettuare controlli qualità: gli attuatori grazie alla combinazione di controllo sofisticato, software dedicato al controllo qualità e componenti meccanici di elevata precisione sono perfetti per effettuare test ripetuti per grandi numeri di cicli anche nel caso di applicazioni H24.



➤ The EA Series / La Serie EA

Measurement and Performance / Dimensione e Prestazioni

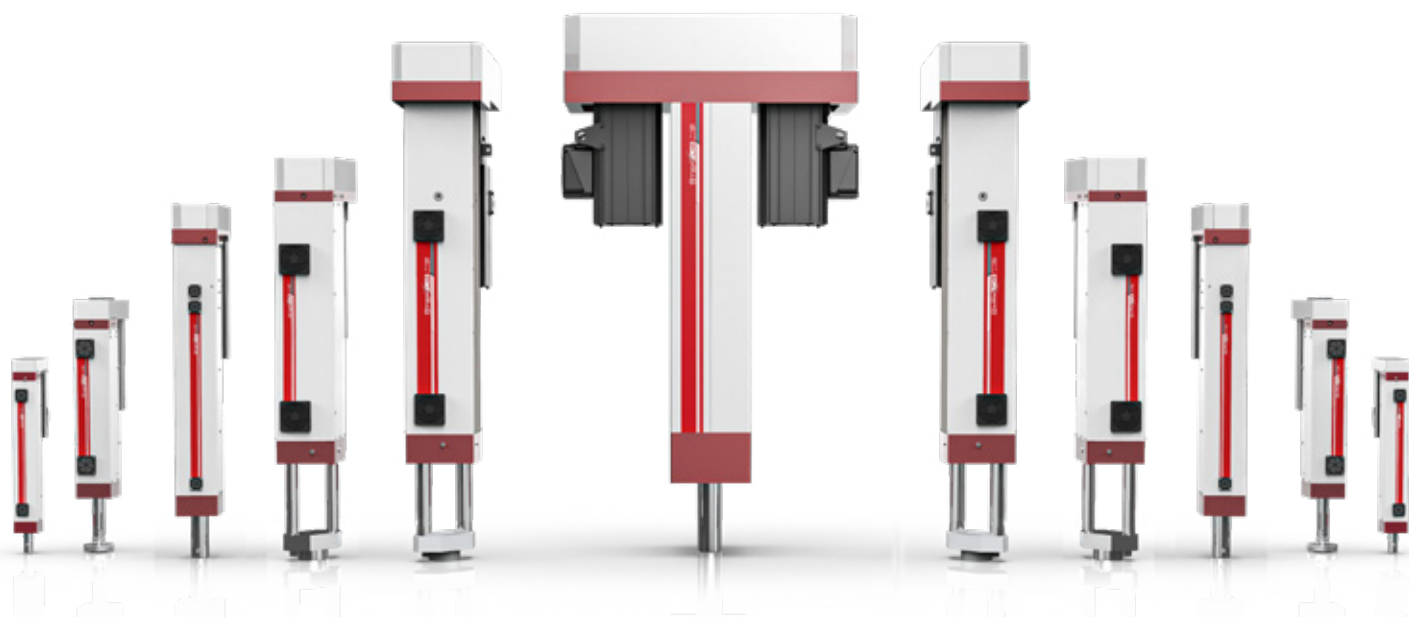

	EA02	EA05	EA015	EA050	EA100	EA200*
Massima forza dinamica (fatica sinusoidale) Max. Dynamic Force (Sinusoidal Fatigue) [kN]	2.0	5.5	16.0	50.0	100.0	200.0
Massima forza statica Max. Static Force [kN]	4.0	14.8	34.0	49.9	139.0**	278.4**
Massima velocità di prova Max. Test Speed [mm/s]	800	1250	500	505	800	535
Corsa Standard Standard Stroke [mm] *	250	250	300	200	200	200
Frequenza Frequency [Hz]	35	30	25	20	20	20
A - Lunghezza A - Length [mm]	570	653	952	1100	1320	1500
B - Larghezza B - Width [mm]	75	115	135	185	280	425
C - Profondità C - Depth [mm]	160	240	320	370	600	940
D - Lunghezza con pistone D - Length with piston [mm]	642	737	1050	1250	1554	1745
Temp. ambiente Ambient Temp. [°C]	5 - 35	5 - 35	5 - 35	5 - 35	5 - 35	5 - 35

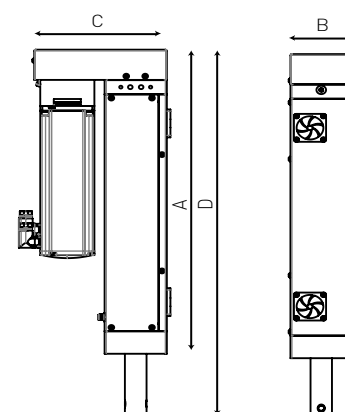

* Other values available under request. / Altri valori disponibili su richiesta. | **Configuration for heavy loads with low dynamic. / Configurazione dedicata ad alti carichi a bassa dinamica.
NOTE / NOTES: I valori di forza e velocità riportati non rappresentano una configurazione specifica, ma i valori massimi ottenibili in differenti configurazioni. Contattaci per ulteriori informazioni.
/ Force and speed values aren't the values for a particular configuration. They are the maximum reachable values in different configurations. Please contact us for more information.
Dettagli e dimensioni possono differire, in funzione della configurazione. / Details and dimensions may differ, in function of the configuration.

Integration with Test Center / Integrazione con Test Center

STEP Lab provides a complete software and electronic solution for the management of the EA series actuators. The solution offered by the Test Center Software is extremely flexible and can manage multi-axis systems, safety devices, and other accessories such as climatic cells, grips, optical and contact extensometers, automated support structures, as well as interfacing with third-party company management systems.

STEP Lab fornisce una soluzione software ed elettronica completa per la gestione degli assi della serie EA. La soluzione è estremamente flessibile e può gestire anche sistemi multi asse, sicurezze, ed ulteriori accessori quali celle climatiche, griffe, estensometri ottici e a contatto, strutture di supporto automatizzate, oltre ad interfacciarsi con gestionali aziendali di terze parti

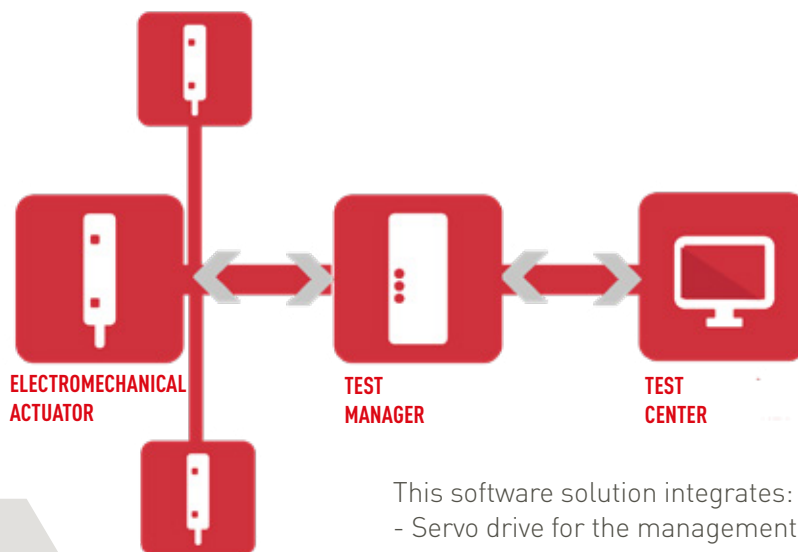

This software solution integrates:

- Servo drive for the management of brushless motors to flexibly manage all types of applications in both low and high dynamics.
- A real-time controller for advanced motor management with the ability to run applications in:
 - Position control
 - Load control
 - Control on a transducer other than the load cell, such as pressure sensors, strain gauges, optical extensometers
 - Synchronized and non-synchronized multi-actuator mode.
- Windows-based user interface software for setting up, acquiring, and evaluating tests on products and materials.

Questa soluzione software integra:

- *Un servo drive per la gestione di motori brushless per gestire in modo flessibile tutte le tipologie di applicazioni sia in bassa che alta dinamica.*
- *Un controllore real time per la gestione avanzata dei motori con la possibilità di eseguire applicazioni in:*
 - *Controllo di posizione*
 - *Controllo di carico*
 - *Controllo su trasduttore diverso dalla cella di carico, quale ad esempio sensori di pressione estensimetri, estensometri ottici.*
 - *Modalità multi-attuatore sincronizzato e non*
- *Software di interfaccia utente basato su sistema Windows per l'impostazione, l'acquisizione e la valutazione di test su prodotti e materiali.*



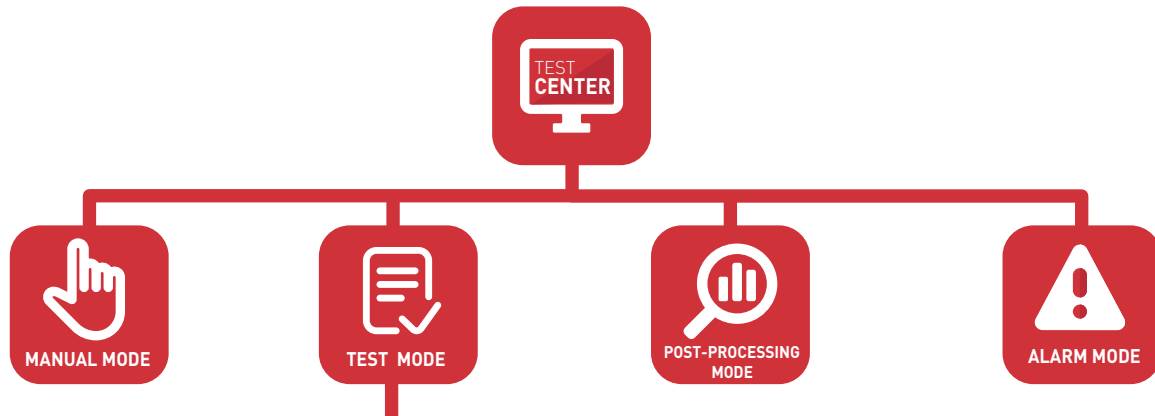

<p>STATIC MODULE Tensile, compression and creep tests</p>		<p>MODULO STATICO Prove di trazione, compressione e creep</p>
<p>DYNAMIC MODULE Fatigue and profile reproduction tests</p>		<p>MODULO DINAMICO Test di fatica e riproduzione del profilo</p>
<p>DMA Dynamic Mechanical Analysis</p>		<p>DMA Analisi Meccanica Dinamica</p>
<p>DAMPER MODULE Characterization and quality control</p>		<p>MODULO AMMORTIZZATORI Caratterizzazione e controllo qualità</p>
<p>SPRING MODULE Characterization and quality control</p>		<p>MODULO MOLLE Caratterizzazione e controllo qualità</p>
<p>FRACTURE MECHANICS MODULE Analysis of crack propagation</p>		<p>MODULO DI MECCANICA DELLA FRATTURA Analisi della propagazione della cricca</p>
<p>MULTIACTION MODULE Programming of complex tests</p>		<p>Programmazione di test complessi</p>
<p>CLIMATIC CHAMBER MODULE Integration of climatic parameters in tests</p>		<p>MODULO CAMERA CLIMATICA Integrazione dei parametri climatici nei test</p>
<p>END OF THE LINE Production line quality control integrated</p>	<p>EOL</p>	<p>END OF THE LINE Controllo qualità della linea di produzione integrato</p>
<p>DYNAMIC HMI MODULE Customization of the interface</p>		<p>MODULO HMI DINAMICO Personalizzazione dell'interfaccia Configurazione + Prove statiche e dinamiche personalizzabili</p>
<p>MULTIAXIS SYNCHRONIZED MODULE Management of multi synchronized actuators</p>		<p>MODULO MULTIASSE SINCRONIZZATO Gestione di più attuatori sincronizzati</p>
<p>MULTIAXIS INDEPENDENT MODULE Share controller between independent actuators</p>		<p>MODULO MULTIASSE INDIPENDENTE Condivisione del controller tra attuatori Indipendenti</p>

EA02

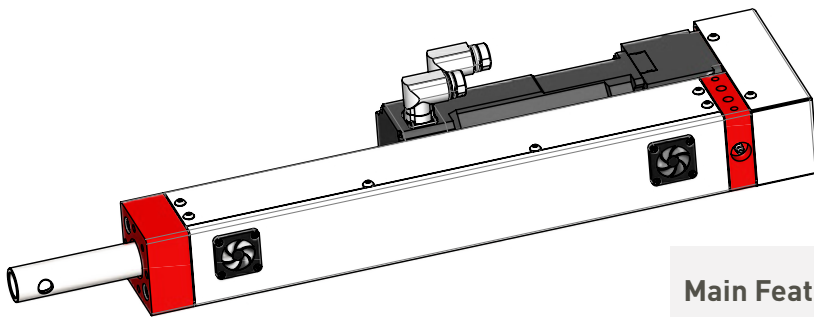
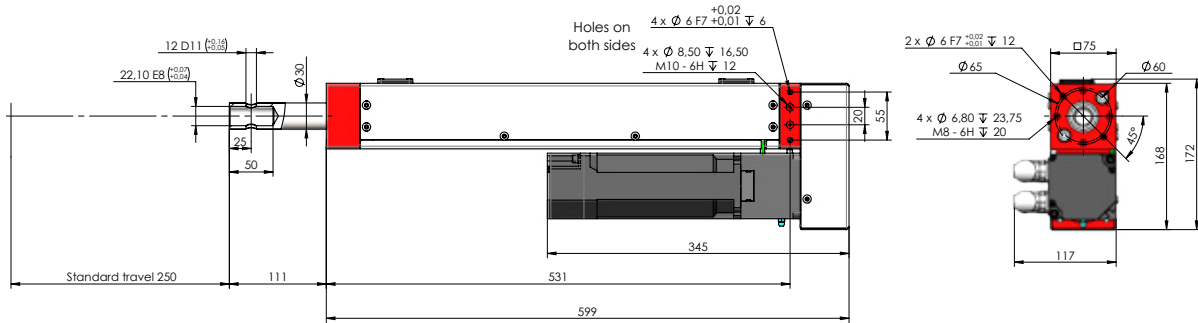

Main Features*

- + Maximum Dynamic Force 2.0 kN
- + Maximum Static Force 4.0 kN

Configuration and Codes / Configurazioni e Codici

	Code	Static Force (N)	Dynamic Force (N)	Acceleration (g)	Max. Speed (mm/s)	Standard Stroke (mm)
EA02	EA02-5/400/N-H16/1-250	480	630	0.99	800	250
	EA02-5/400/N-H10/1-250	780	1010	0.65	500	
	EA02-5/400/N-H5/1-250	1550	1490	0.33	250	
	EA02-3/04/3A-H16/1-250	1270	1330	1.50	800	
	EA02-3/04/3A-H10/1-250	2030	1690	0.96	500	
	EA02-3/04/3A-B5/1-250	4000	2000	0.48	250	

* Other configurations available upon request. / Altre configurazioni disponibili su richiesta.

Stroke Limit Speed limit Acceleration limit Frequency Limit Total Performance

Performance chart - EA02-5/400/N-H16/1-250

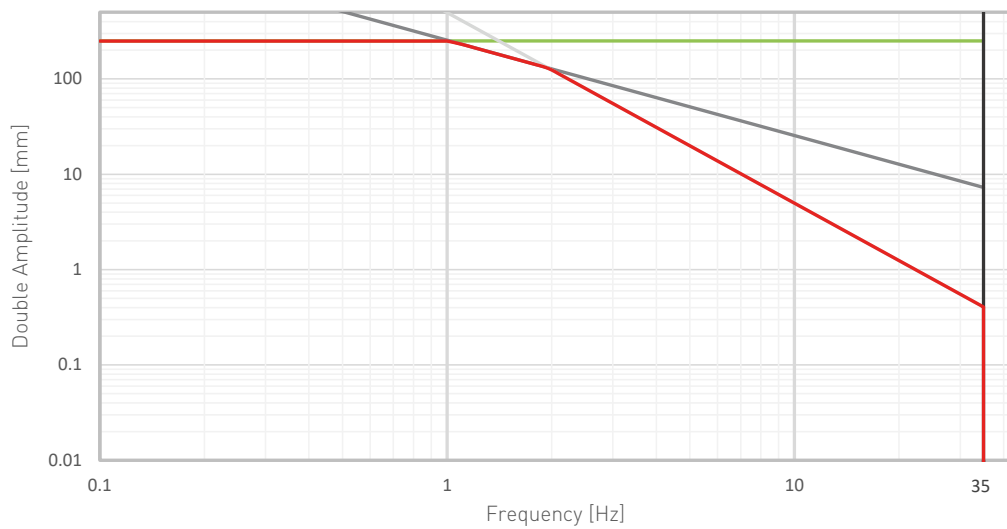

Performance chart - EA02-5/400/N-H10/1-250

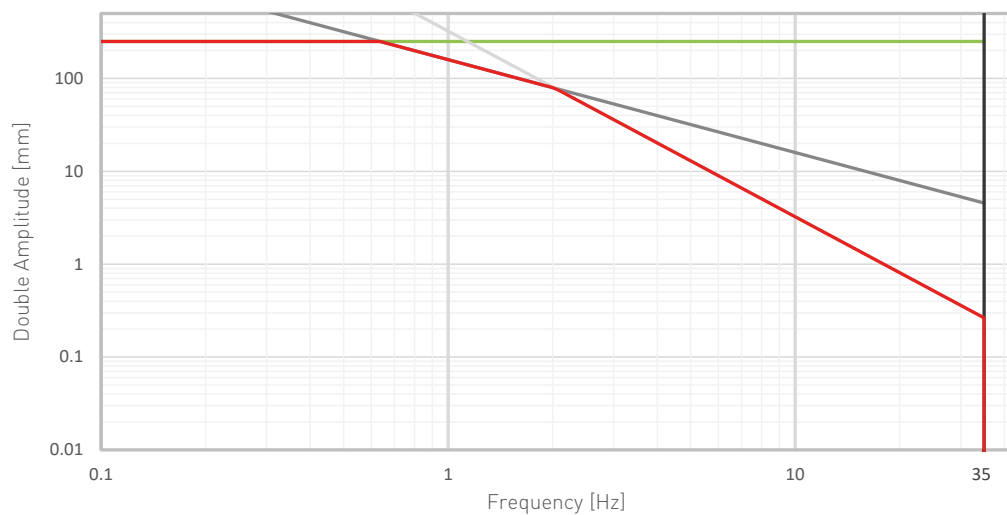

Performance chart - EA02-5/400/N-H5/1-250

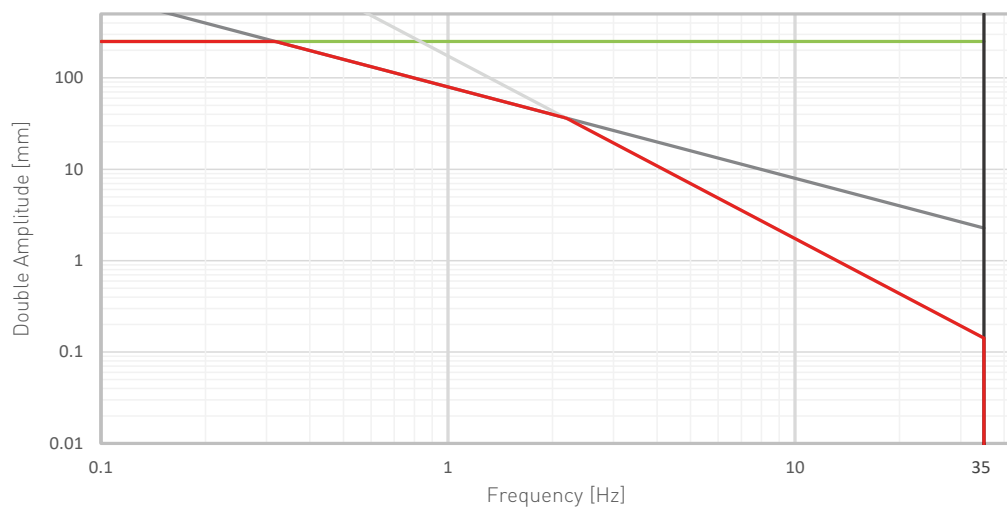

— Stroke Limit — Speed limit — Acceleration limit — Frequency Limit — Total Performance

Performance chart - EA02-3/04/3A-H16/1-250

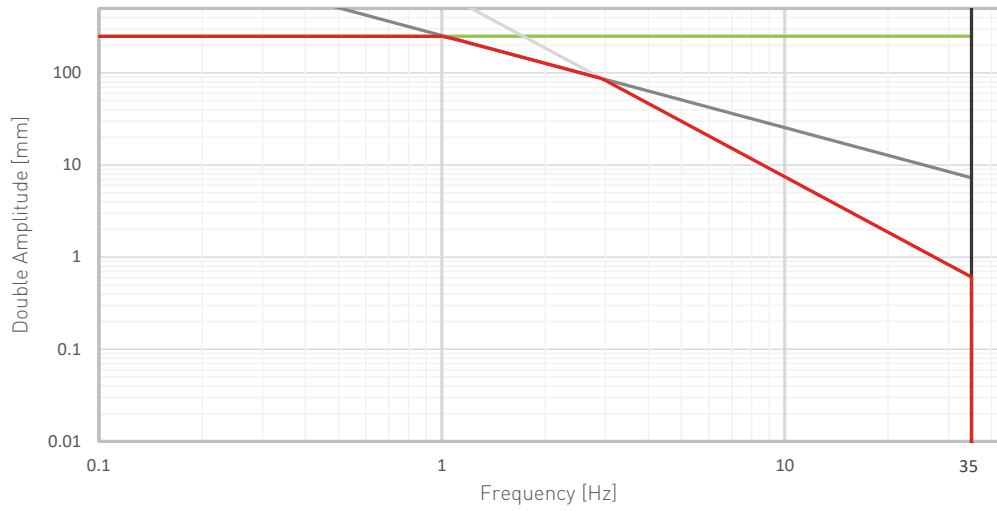

Performance chart - EA02-3/04/3A-H10/1-250

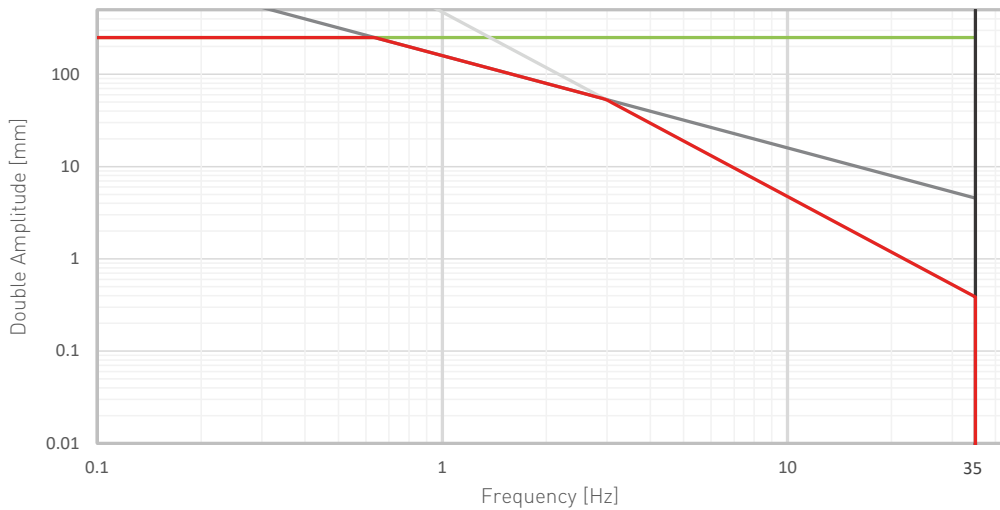

Performance chart - EA02-3/04/3A-B5/1-250

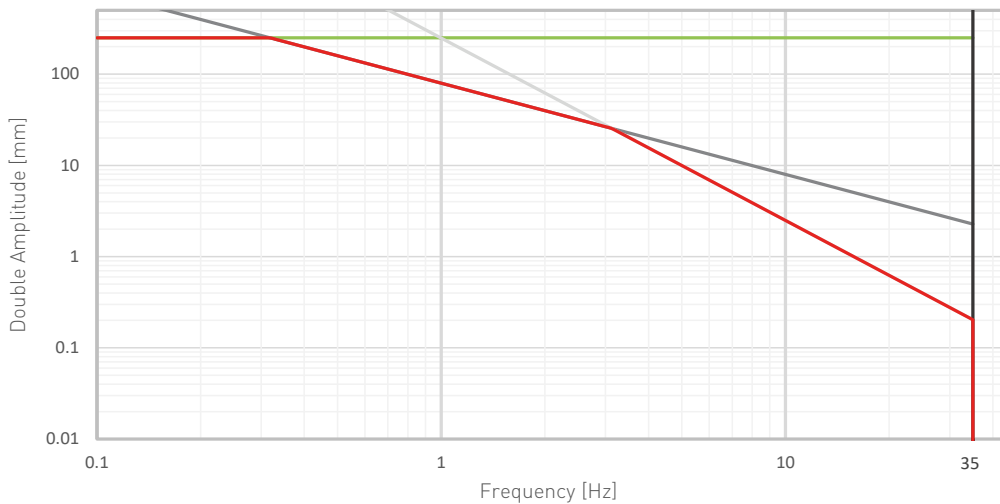

Performance Charts with Torque and Side Force / Tabelle Prestazioni con Carico Torsionale e Laterale*

Permissible side load for a given torque
EA02 - stroke 250 mm

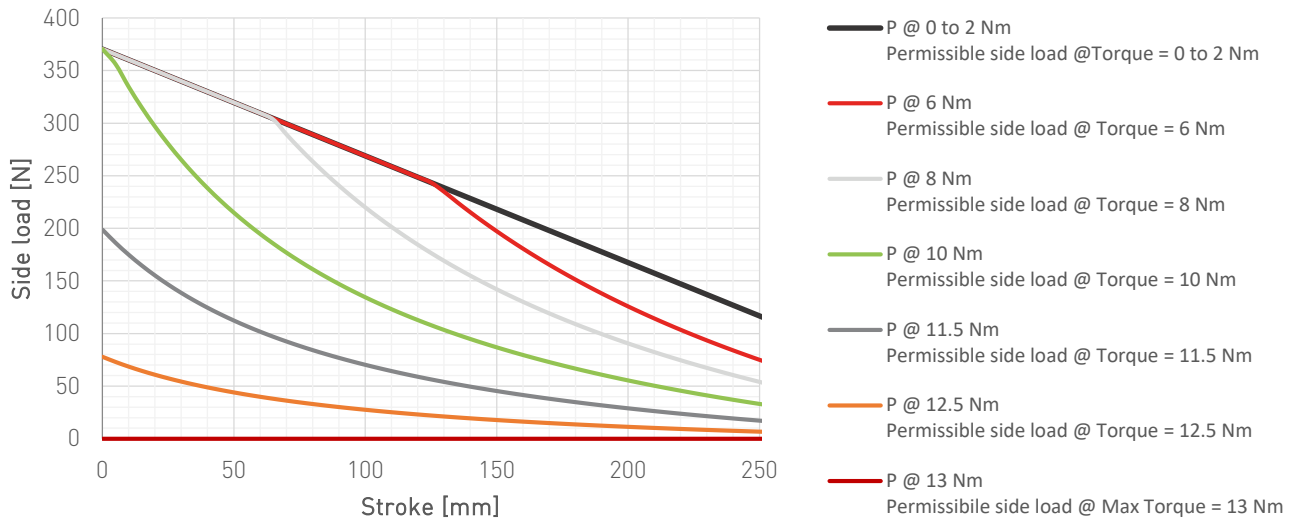

Permissible torque for a given side load
EA02 - stroke 250 mm

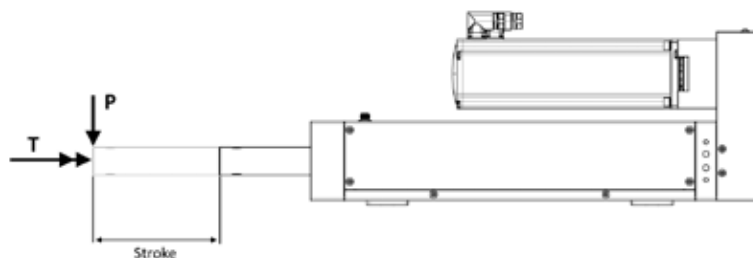
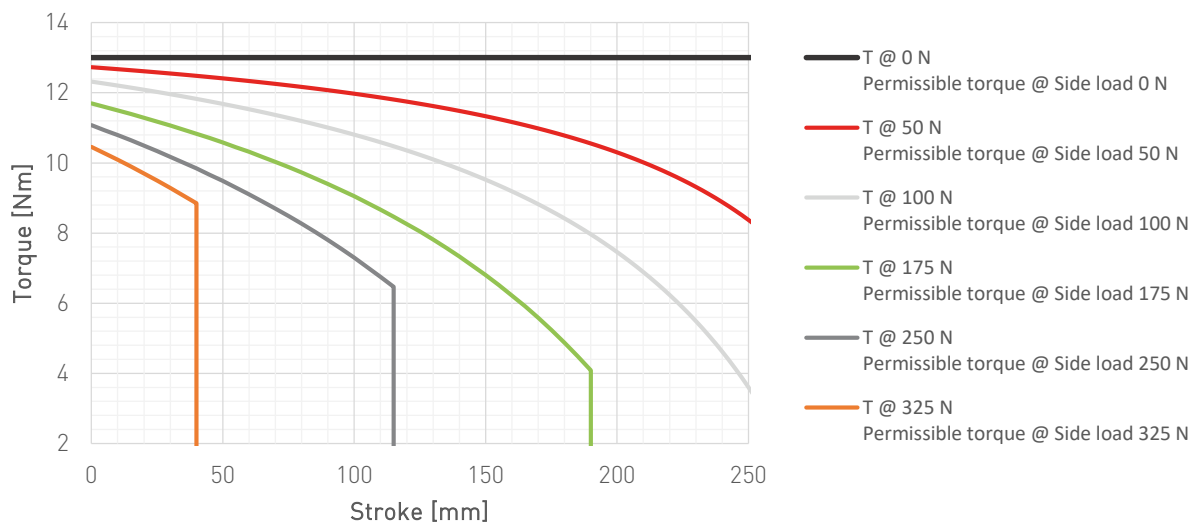

* These tables are intended for an indicative sizing. The final sizing will be provided by STEP Lab based on the request. /
Queste tabelle sono da usare per un dimensionamento indicativo. Il dimensionamento finale verrà fornito da STEP Lab in base alla richiesta.

Stroke Limit Speed limit Acceleration limit Frequency Limit Total Performance

Performance chart - EA05-3/04/3A-T25/1-250

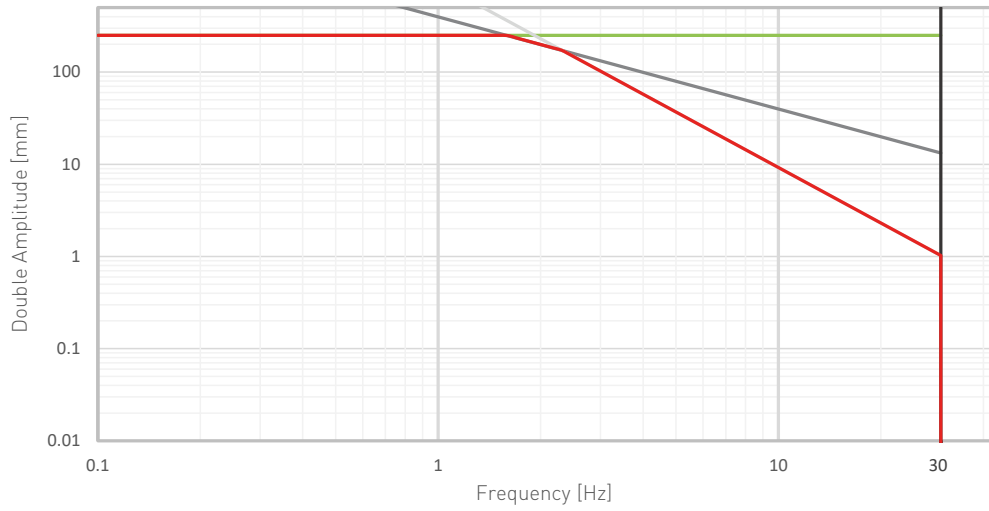

Performance chart - EA05-3/04/3A-T25/1.88-250

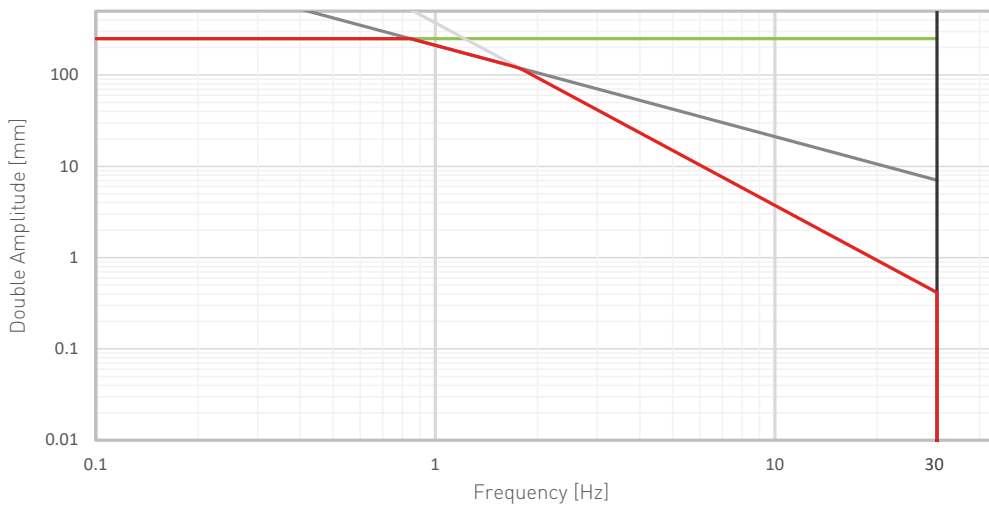

Performance chart - EA05-3/04/3A-T10/1-250

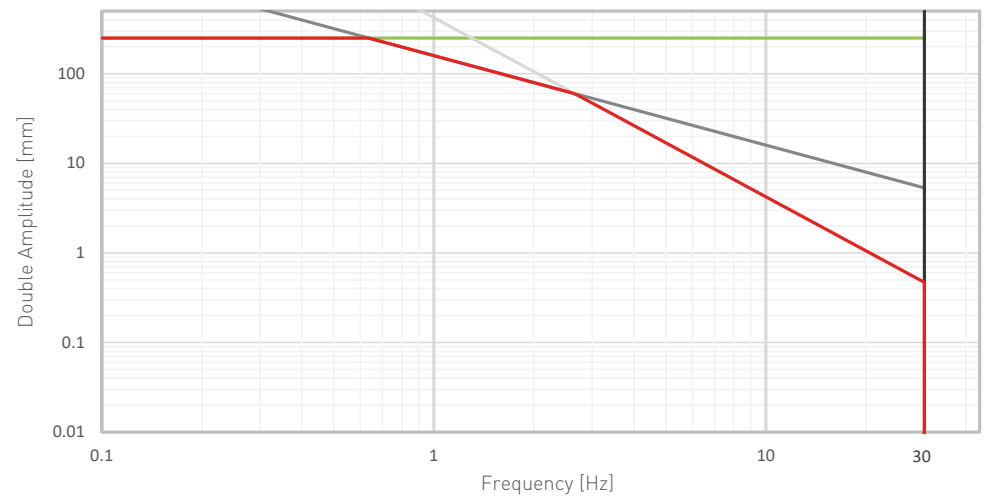

— Stroke Limit — Speed limit — Acceleration limit — Frequency Limit — Total Performance

Performance chart - EA05-3/04/3A-T5/1-250

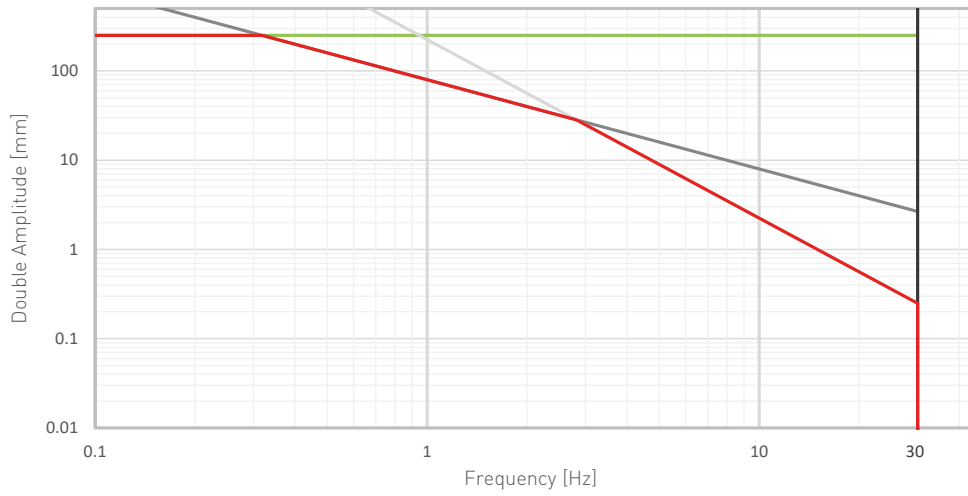

Performance chart - EA05-3/04/3A-T5/2.29-250

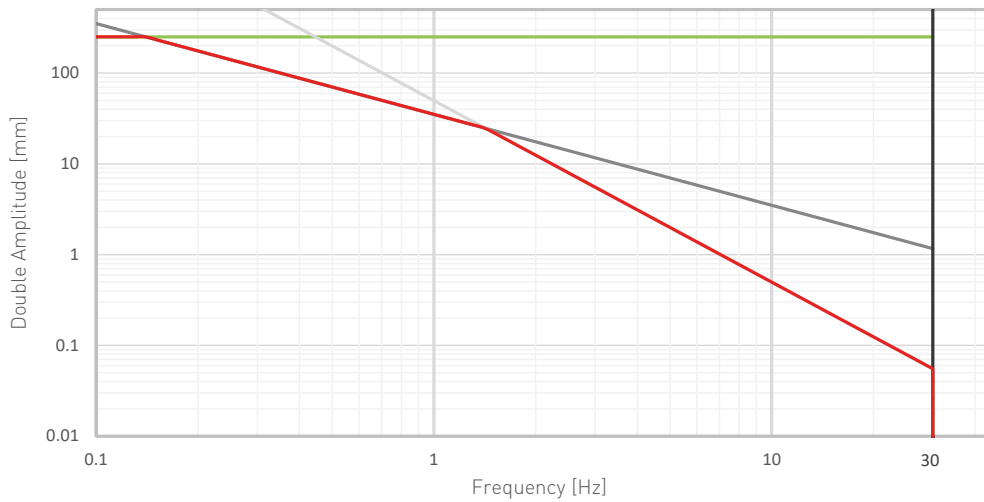

Performance chart - EA05-3/04/3A-B10/1.41-250

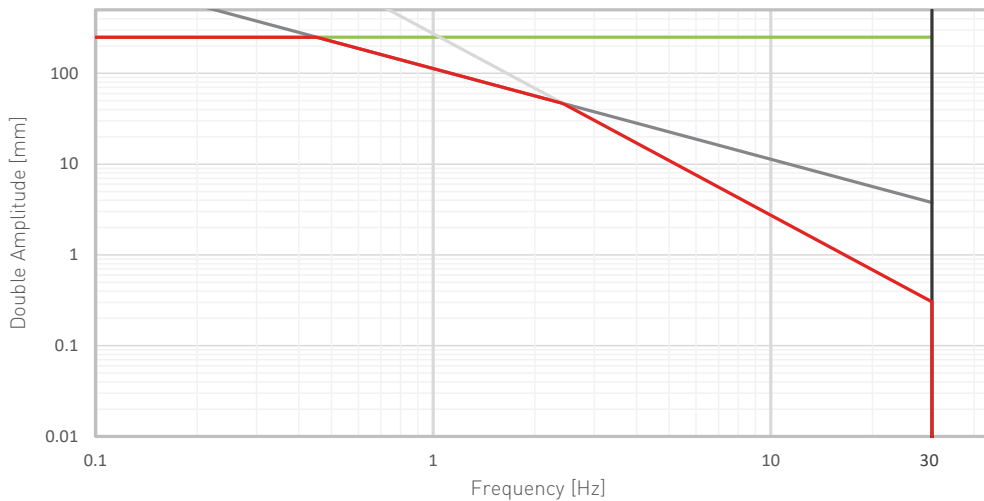

— Stroke Limit — Speed limit — Acceleration limit — Frequency Limit — Total Performance

Performance chart - EA05-3/04/3A-B10/1.88-250

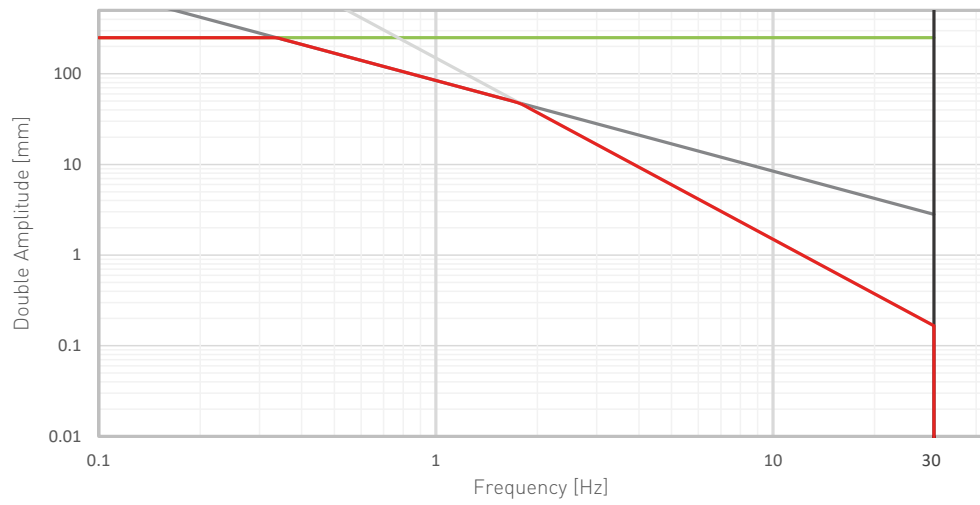

Performance chart - EA05-3/04/3A-B10/2.29-250

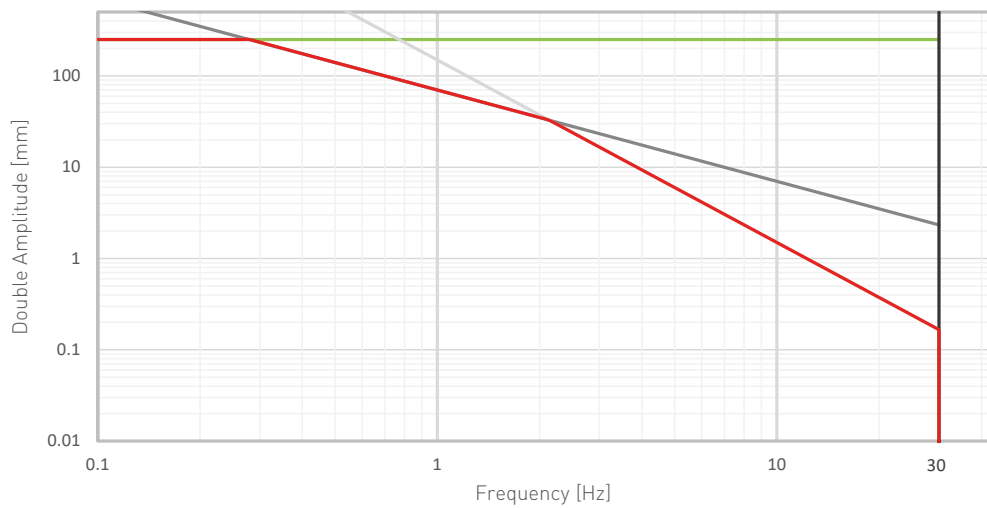

Performance chart - EA05-5/12/6A-T25/1.42-250

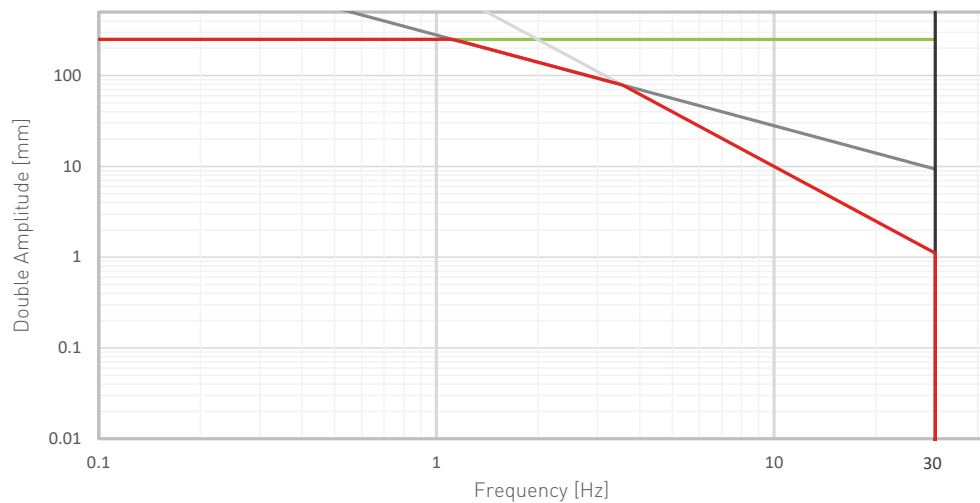

— Stroke Limit — Speed limit — Acceleration limit — Frequency Limit — Total Performance

Performance chart - EA05-5/12/6A-T5/1-250

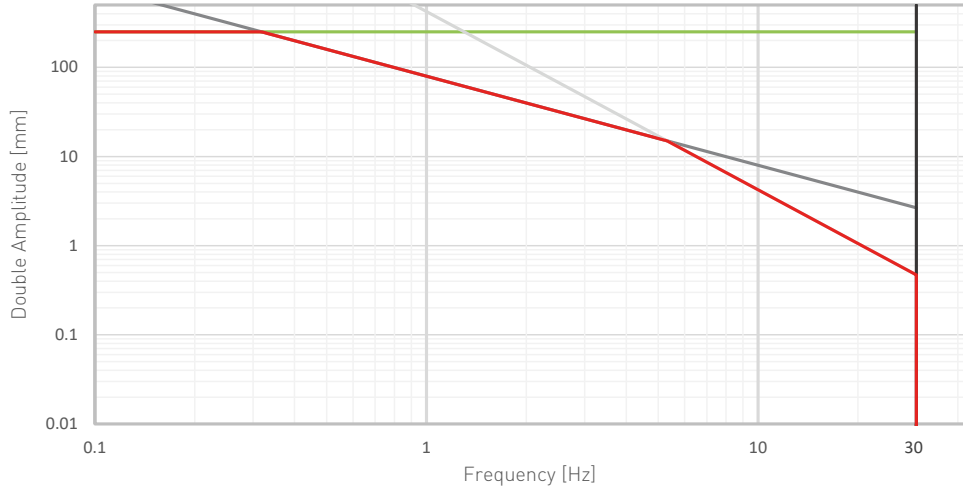

Performance chart - EA05-5/12/6A-B25/1-250

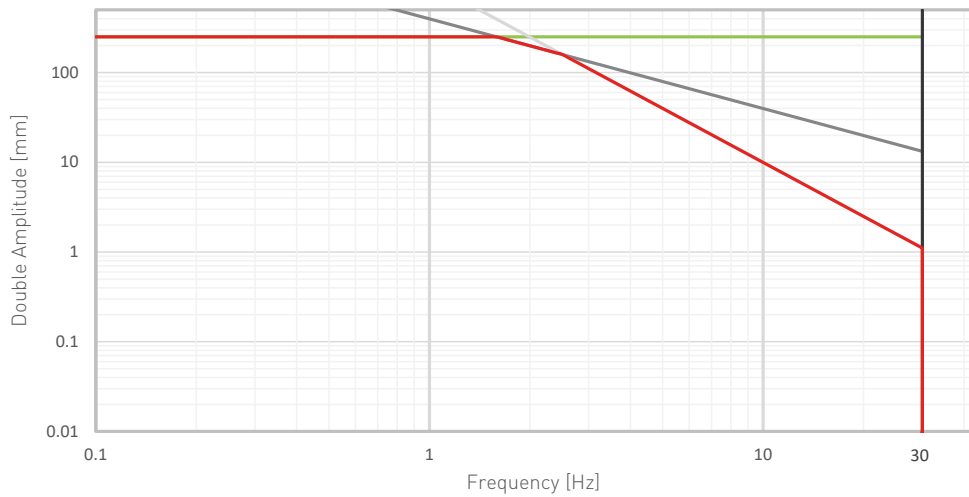

Performance chart - EA05-5/12/6A-B25/1.42-250

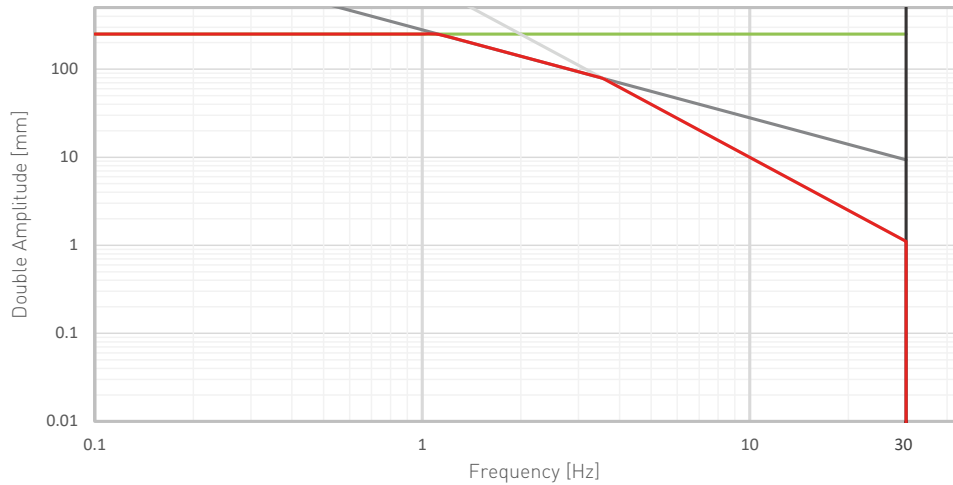

— Stroke Limit — Speed limit — Acceleration limit — Frequency Limit — Total Performance

Performance chart - EA05-5/12/6A-B5/1.18-250

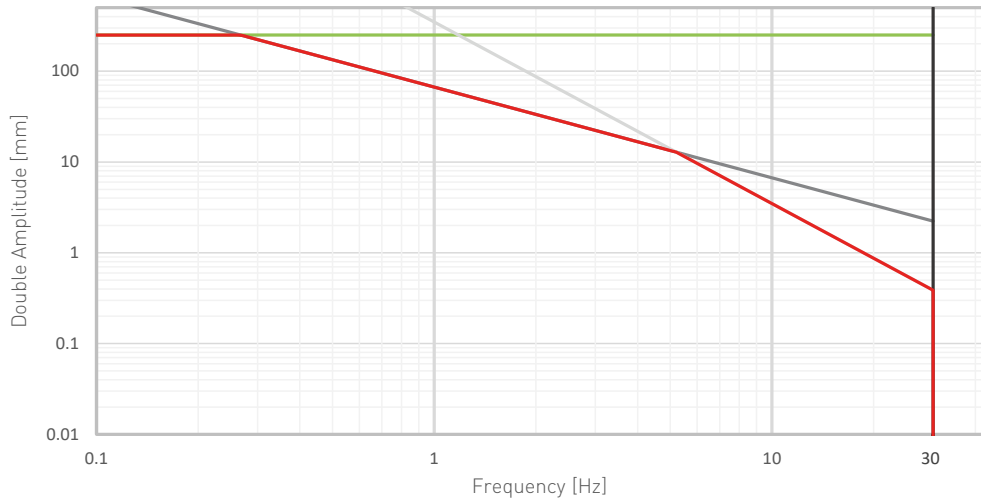

Performance chart - EA05-5/12/3A-B10/1.67-250

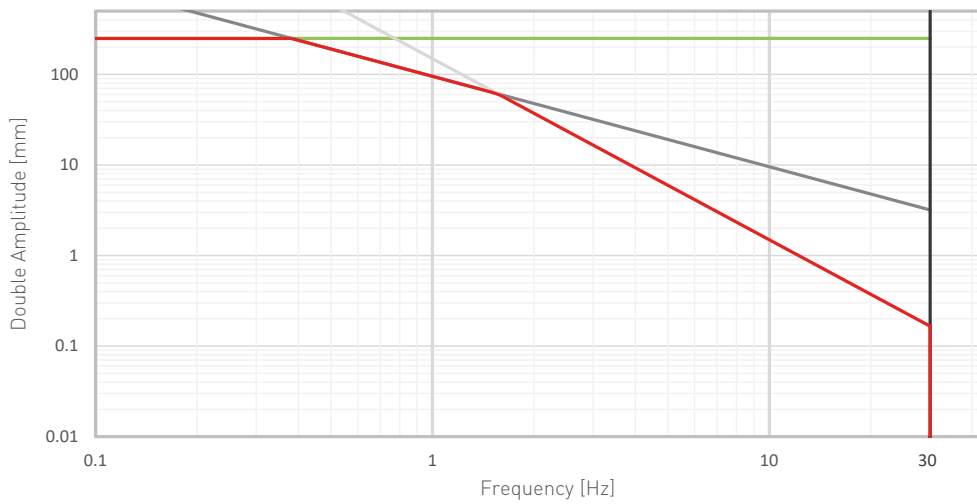

Performance chart - EA05-5/12/6A-B10/1-250

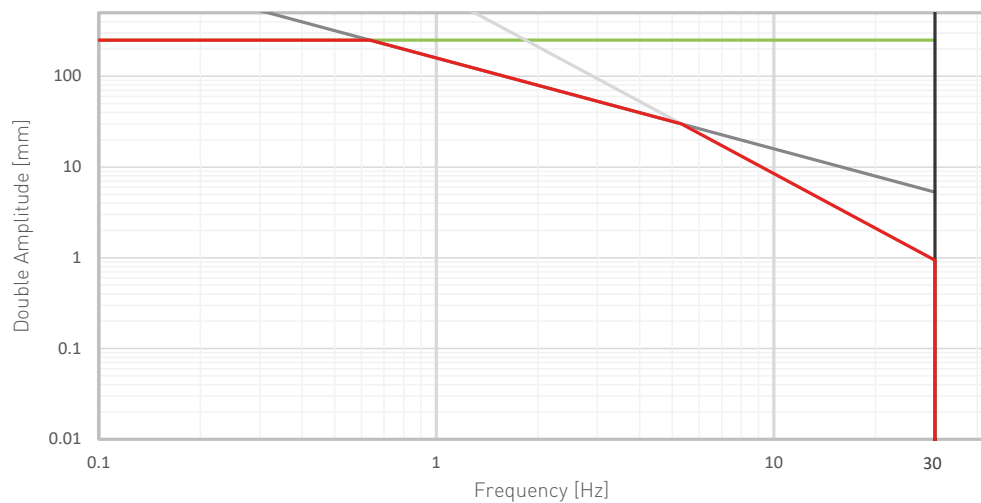

— Stroke Limit — Speed limit — Acceleration limit — Frequency Limit — Total Performance

Performance chart - EA05-5/12/6A-B10/1.67-250

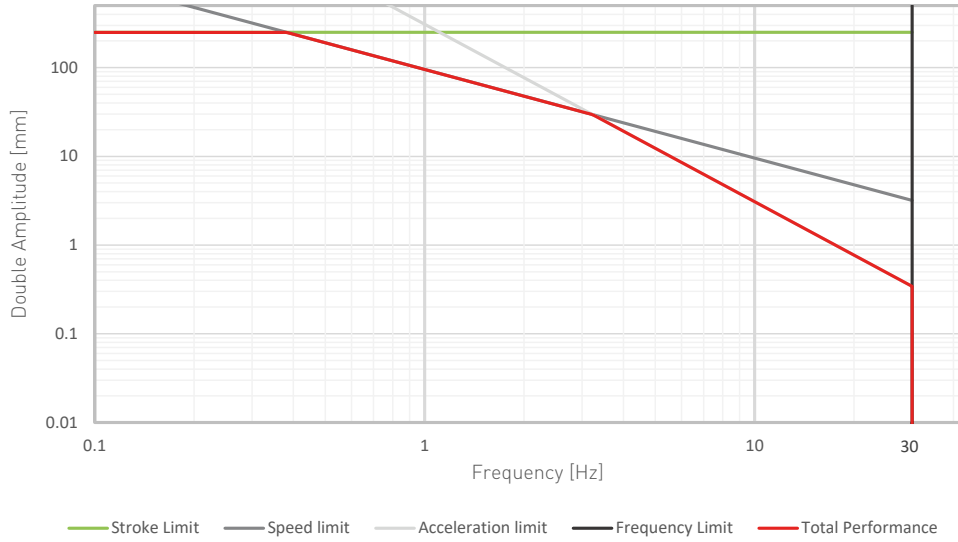

Performance Charts with Torque and Side Force / Tabelle Prestazioni con Carico Torsionale e Laterale*

Permissible side load for a given torque
EA05 - stroke 250 mm

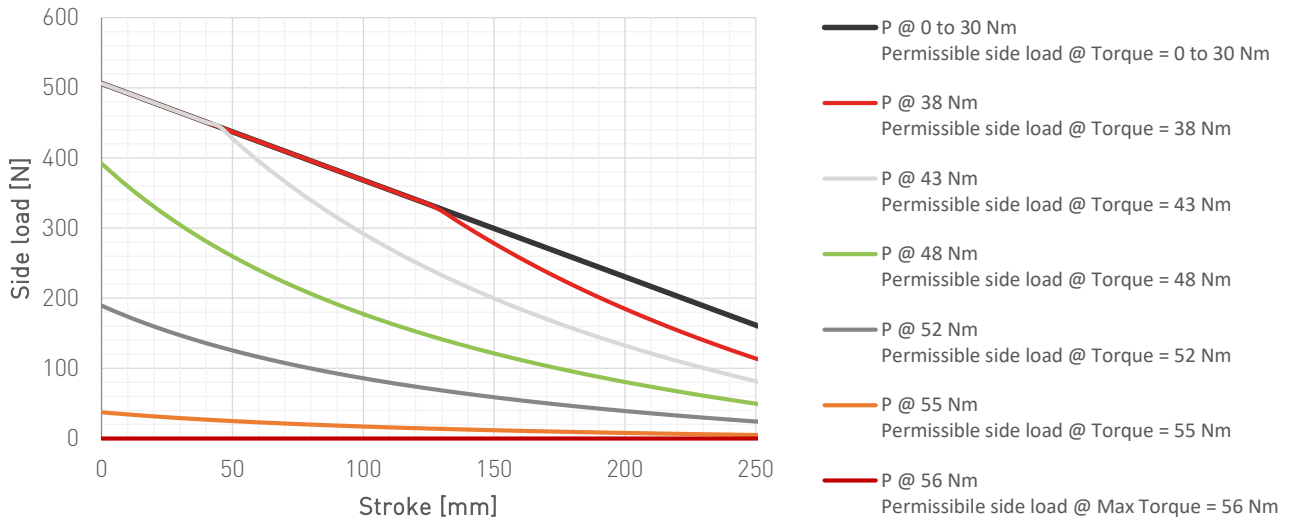

Permissible torque for a given side load
EA05 - stroke 250 mm

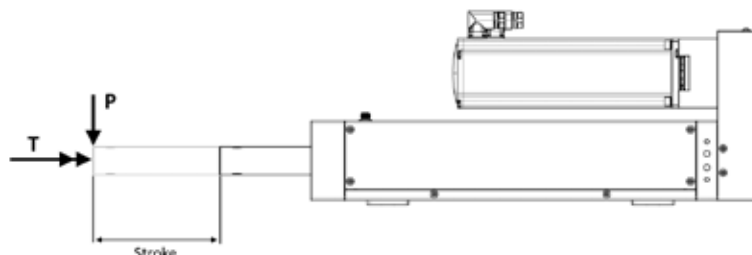
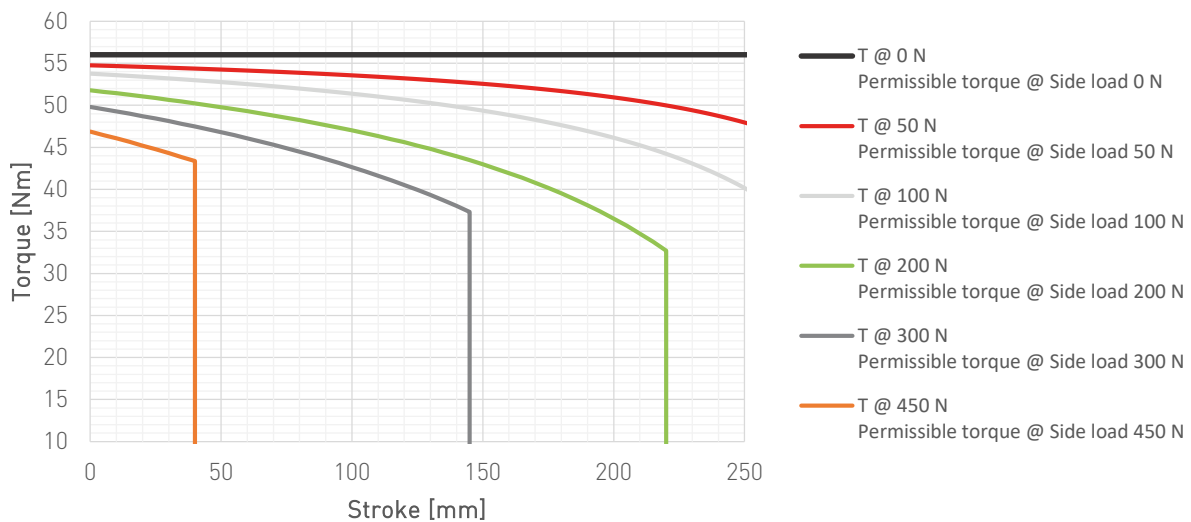

* These tables are intended for an indicative sizing. The final sizing will be provided by STEP Lab based on the request. / Queste tabelle sono da usare per un dimensionamento indicativo. Il dimensionamento finale verrà fornito da STEP Lab in base alla richiesta.

EA015

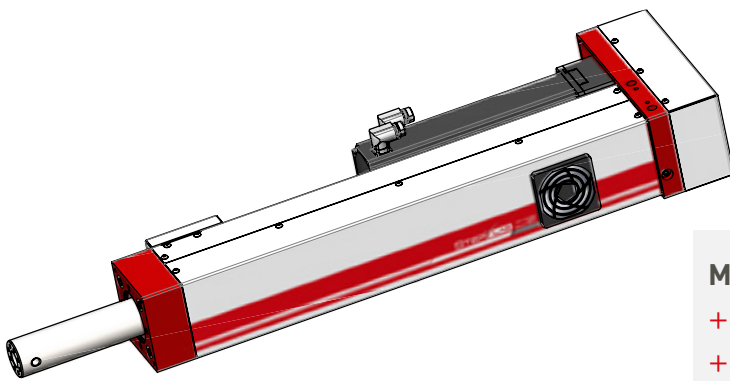
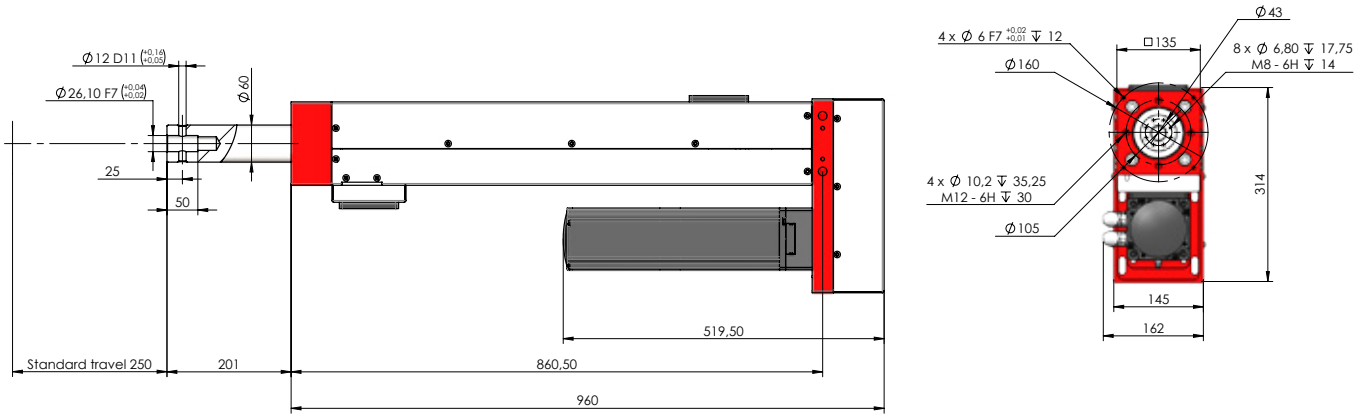

Main Features*

- + Maximum Dynamic Force 16.0 kN
- + Maximum Static Force 34.0 kN

Configuration and Codes / Configurazioni e Codici

	Code	Static Force (N)	Dynamic Force (N)	Acceleration (g)	Max. Speed (mm/s)	Standard Stroke (mm)
	EA015-5/12/6A-T10/1-250	6300	7100	0.93	500	250
	EA015-5/12/6A-B16/1.82-250	7100	10000	0.87	440	
	EA015-5/12/12A-B16/1.82-250	9200	11100	0.97	440	
	EA015-5/12/12A-B16/2.18-250	11100	13300	0.73	365	
EA015	EA015-5/12/12A-B12/2-250	13500	16000	0.47	300	
	EA015-7/40/12A-T10/2-250	30000	7100	0.52	125	
	EA015-7/40/12A-B16/1-250	12700	16000	1.40	535	
	EA015-7/40/12A-B16/2-250	25500	16000	0.81	200	
	EA015-7/40/12A-B12/2-250	34000	16000	0.61	200	

* Other configurations available upon request. / Altre configurazioni disponibili su richiesta.

Stroke Limit Speed limit Acceleration limit Frequency Limit Total Performance

Performance chart - EA015-5/12/6A-T10/1-250

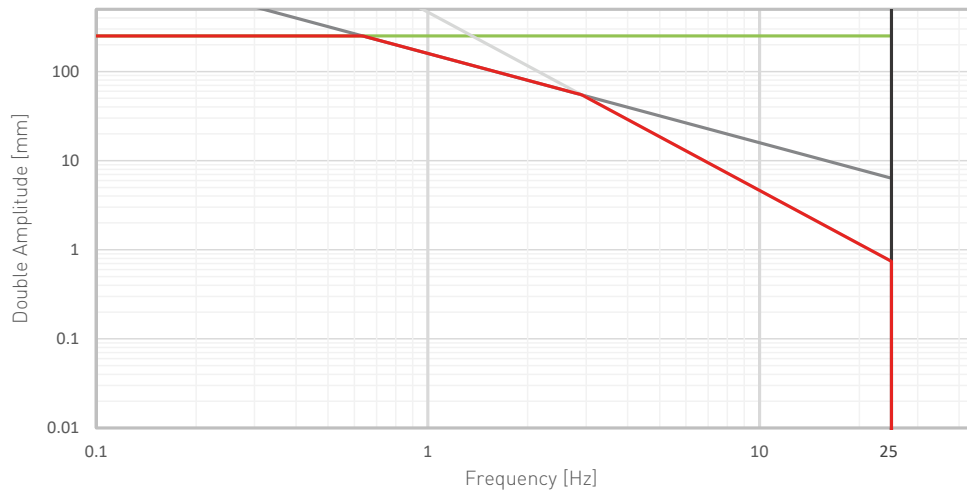

Performance chart - EA015-5/12/6A-B16/1.82-250

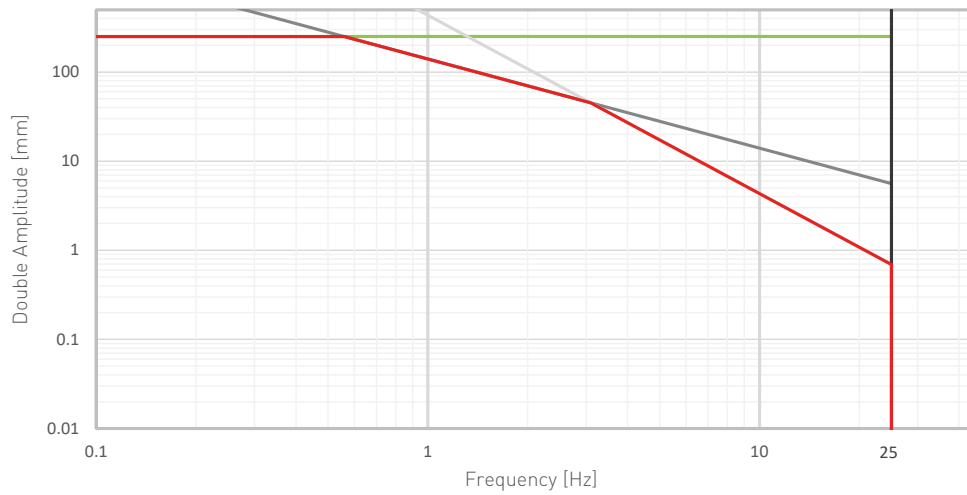

Performance chart - EA015-5/12/12A-B16/1.82-250

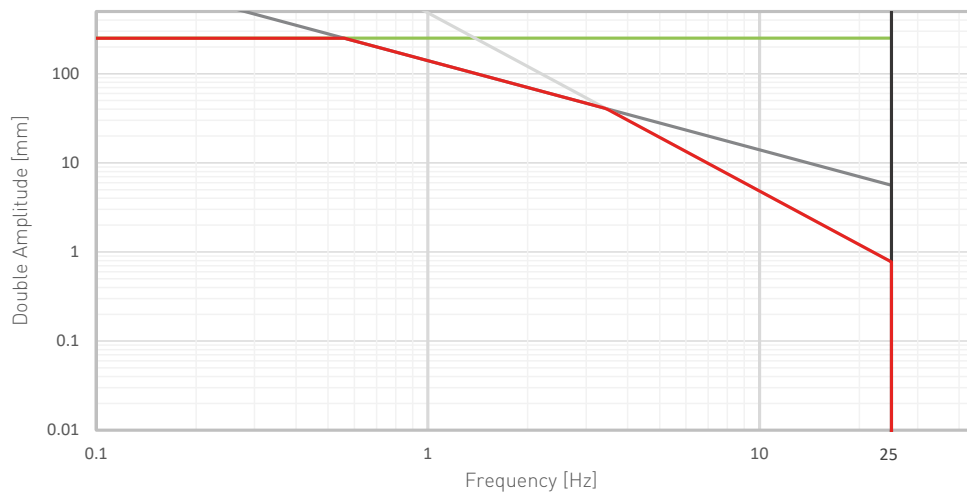

— Stroke Limit — Speed limit — Acceleration limit — Frequency Limit — Total Performance

Performance chart - EA015-5/12/12A-B16/2.18-250

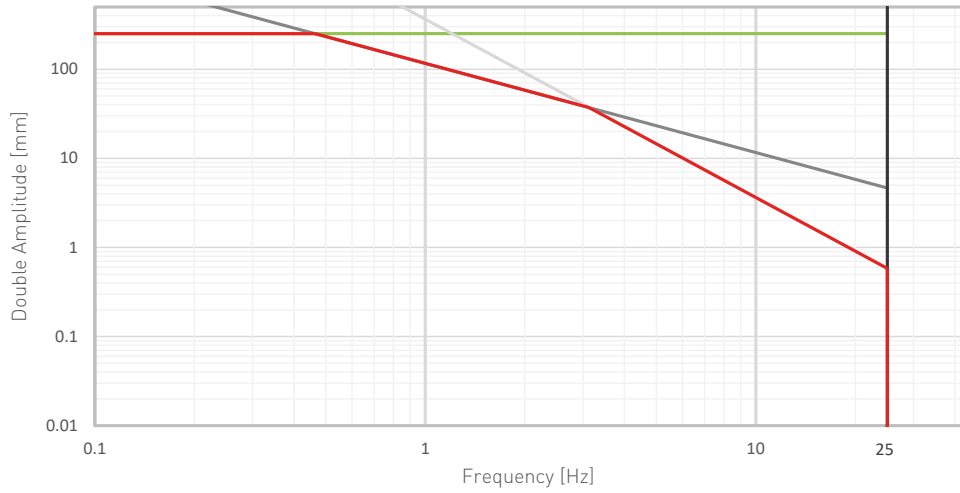

Performance chart - EA015-5/12/12A-B12/2-250

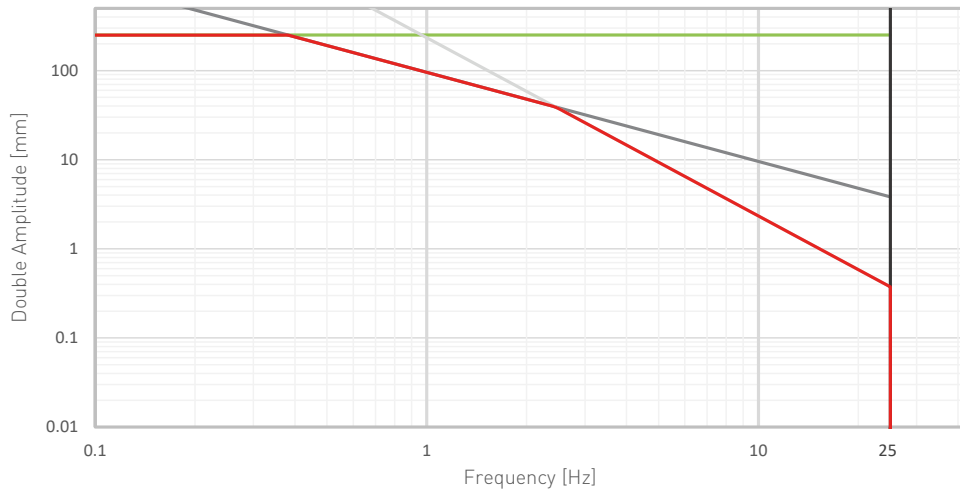

Performance chart - EA015-7/40/12A-T10/2-250

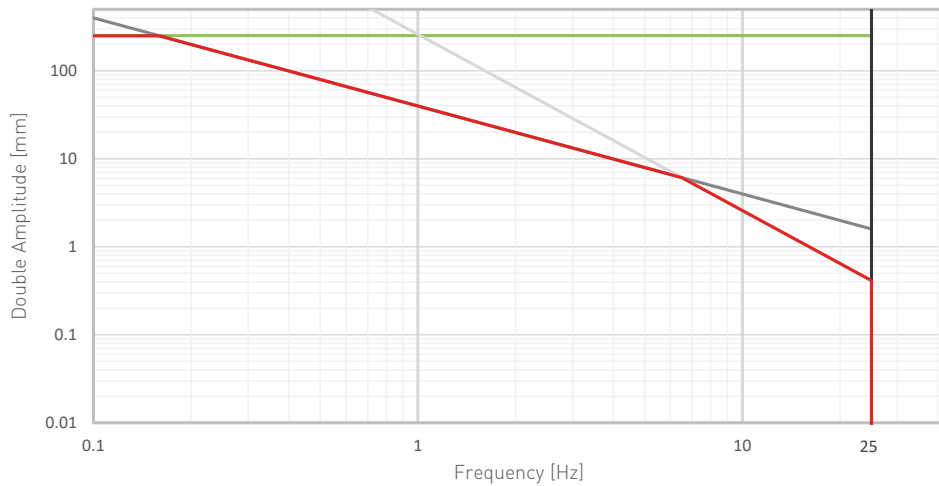

— Stroke Limit — Speed limit — Acceleration limit — Frequency Limit — Total Performance

Performance chart - EA015-7/40/12A-B16/1-250

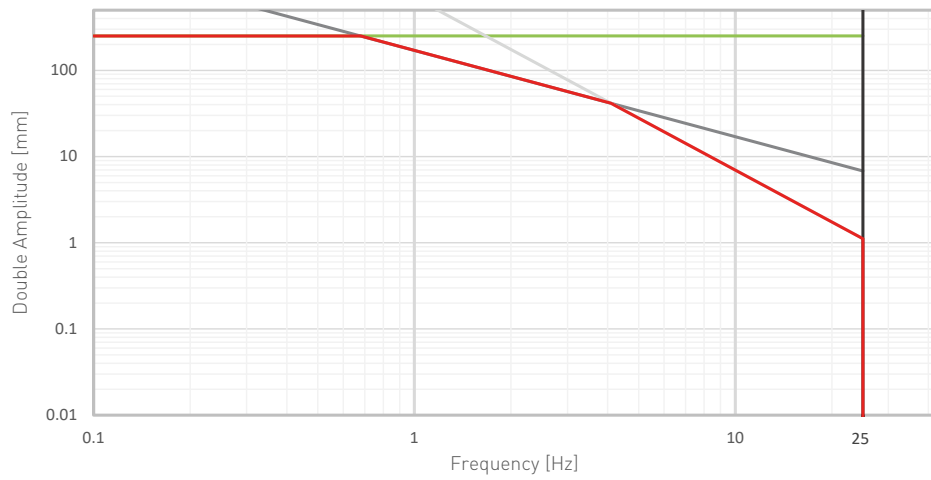

Performance chart - EA015-7/40/12A-B16/2-250

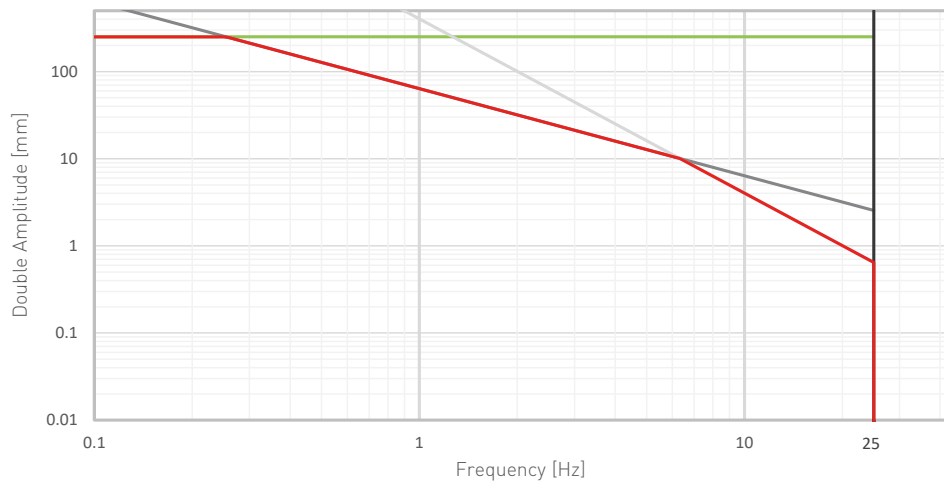

Performance chart - EA015-7/40/12A-B12/2-250

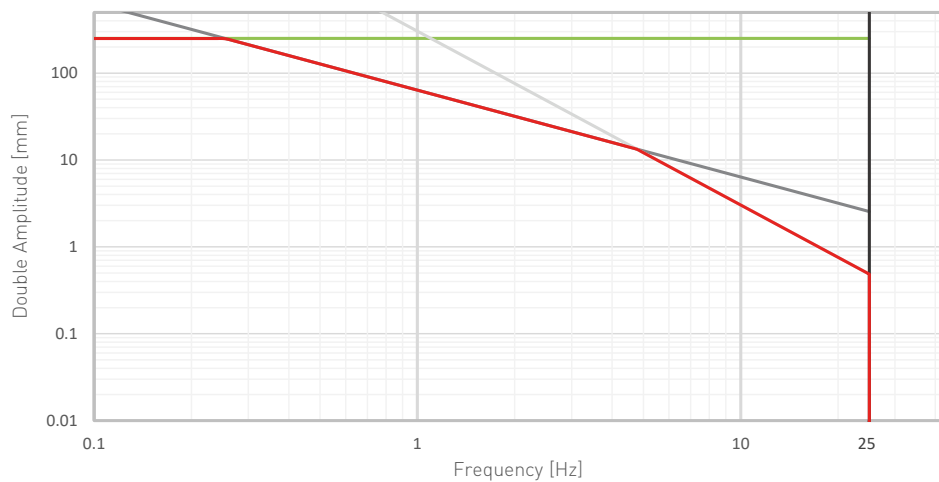

Performance Charts with Torque and Side Force /
Tabelle Prestazioni con Carico Torsionale e Laterale*

Permissible side load for a given torque
EA015 - stroke 250 mm

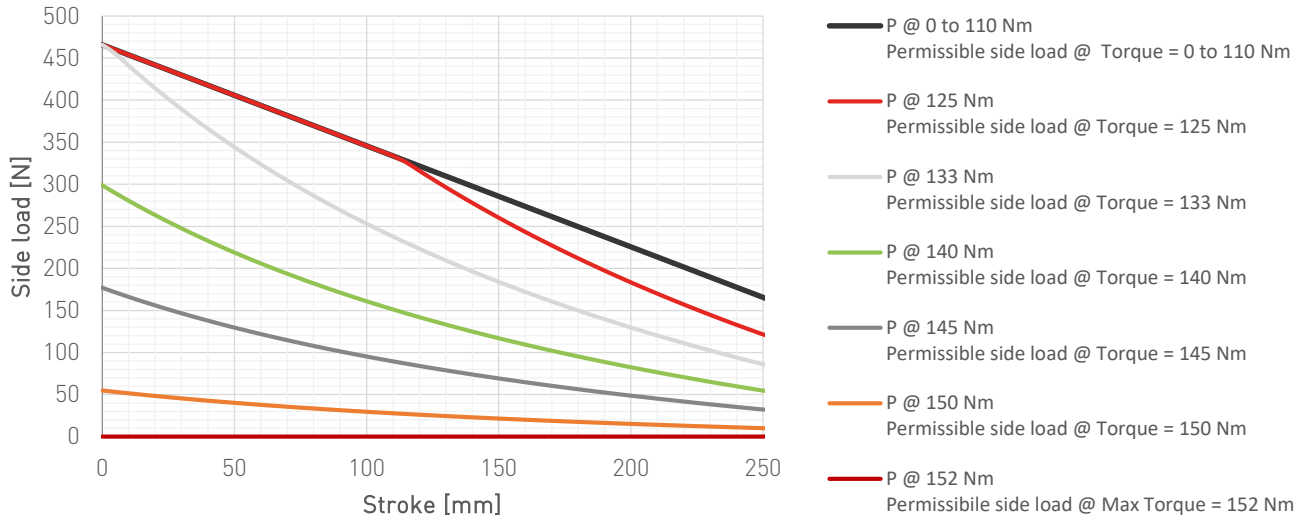

Permissible torque for a given side load
EA015 - stroke 250 mm

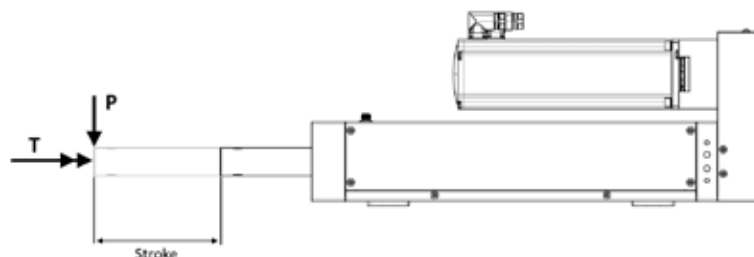

* These tables are intended for an indicative sizing. The final sizing will be provided by STEP Lab based on the request. /
Queste tabelle sono da usare per un dimensionamento indicativo. Il dimensionamento finale verrà fornito da STEP Lab in base alla richiesta.

EA050 - Configuration with Dynamic Force up to 20 kN

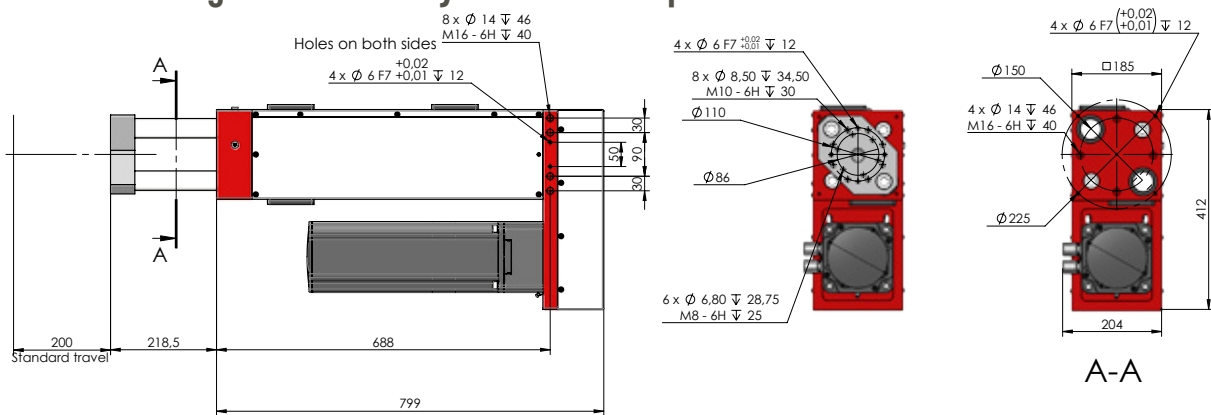

EA050 - Configuration with Dynamic Force over 20 kN

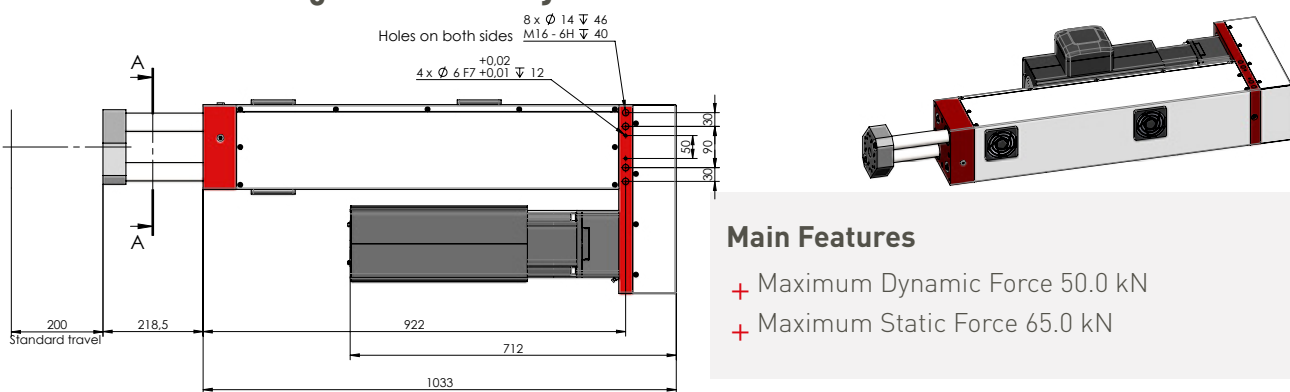

Main Features

- + Maximum Dynamic Force 50.0 kN
- + Maximum Static Force 65.0 kN

Configuration and Codes / Configurazioni e Codici

	Code	Static Force (N)	Dynamic Force (N)	Acceleration (g)	Max. Speed (mm/s)	Standard Stroke (mm)
EA050	EA050-5/12/6A-T10/1.55-200	9700	9100	0.43	325	200
	EA050-7/40/12A-T10/1.85-200	37600	9100	0.49	180	
	EA050-7/40/12A-B20/1.54-200	15700	19900	1.20	435	
	EA050-7/40/12A-B20/1.69-200	17200	19900	1.05	395	
	EA050-7/40/12A-N16/1.54-200	19600	25700	0.90	345	
	EA050-7/40/12A-N16/1.85-200	23500	30800	0.74	290	
	EA050-7F/40/24A-B10/2.29-200	65000	15300	0.47	145	
	EA050-7F/40/24A-B20/1.41-200	24600	19900	1.50	470	
	EA050-7F/40/24A-N16/1.06-200	23100	30400	1.50	505	
	EA050-7F/40/24A-N16/1.41-200	30800	40500	1.15	380	
	EA050-7F/40/24A-N16/1.47-200	32100	42300	0.75	360	
	EA050-7F/40/24A-N16/1.78-200	38800	50000	0.69	300	
	EA050-7F/40/24A-N16/2.29-200	49900	50000	0.75	235	

— Stroke Limit — Speed limit — Acceleration limit — Frequency Limit — Total Performance

Performance chart - EA050-5/12/6A-N10/1.55-200

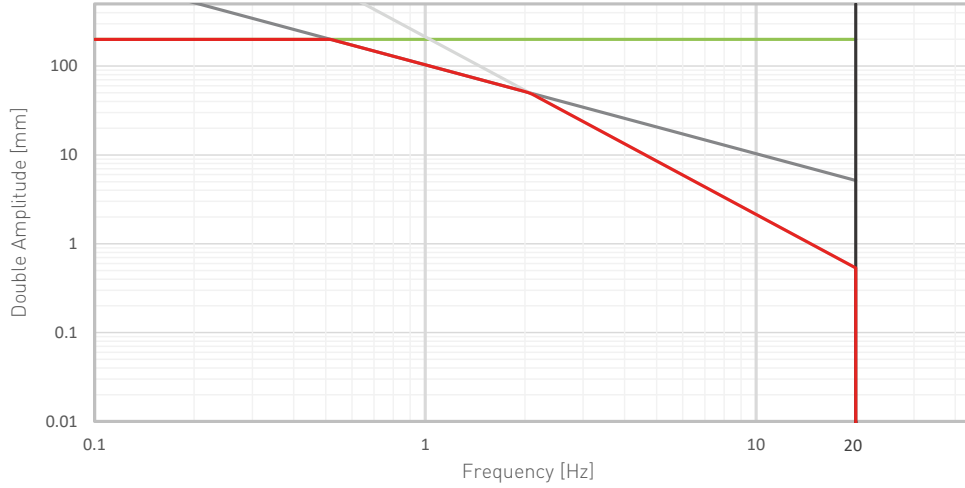

Performance chart - EA050-7/40/12A-T10/1.85-200

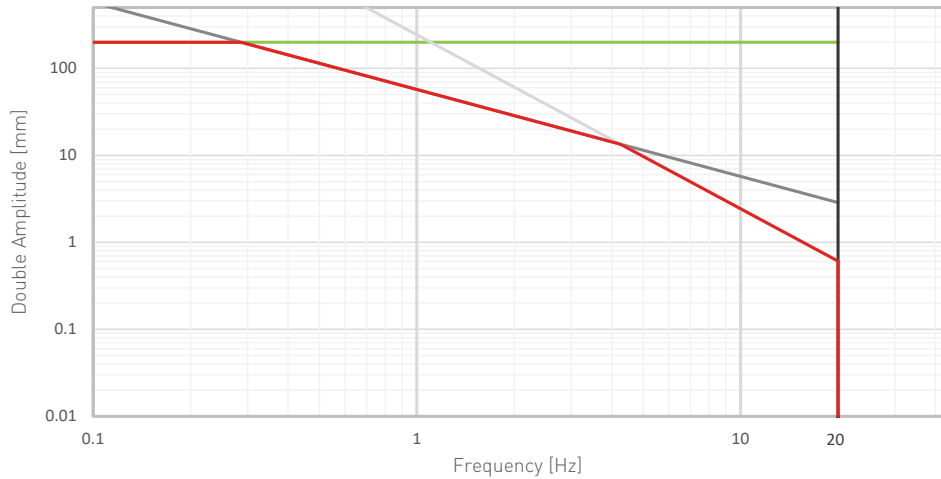

Performance chart - EA050-7/40/12A-B20/1.54-200

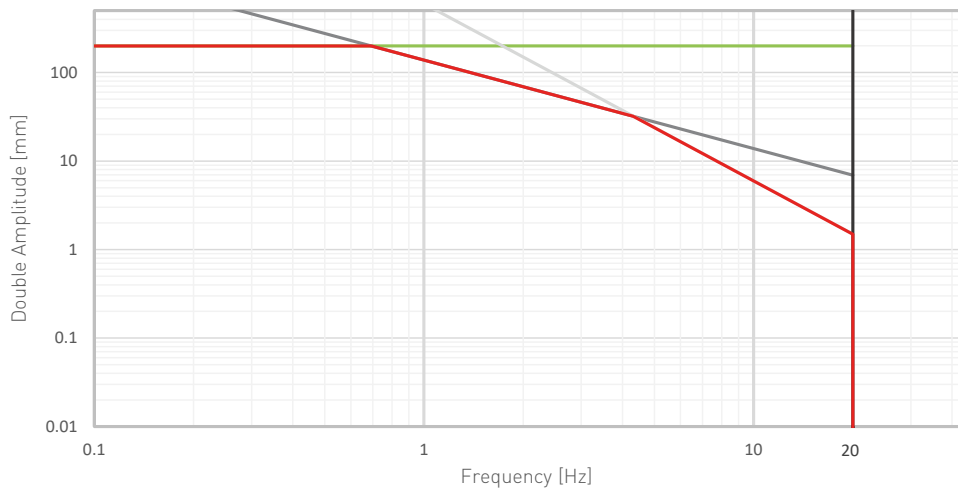

— Stroke Limit — Speed limit — Acceleration limit — Frequency Limit — Total Performance

Performance chart - EA050-7/40/12A-B20/1.69-200

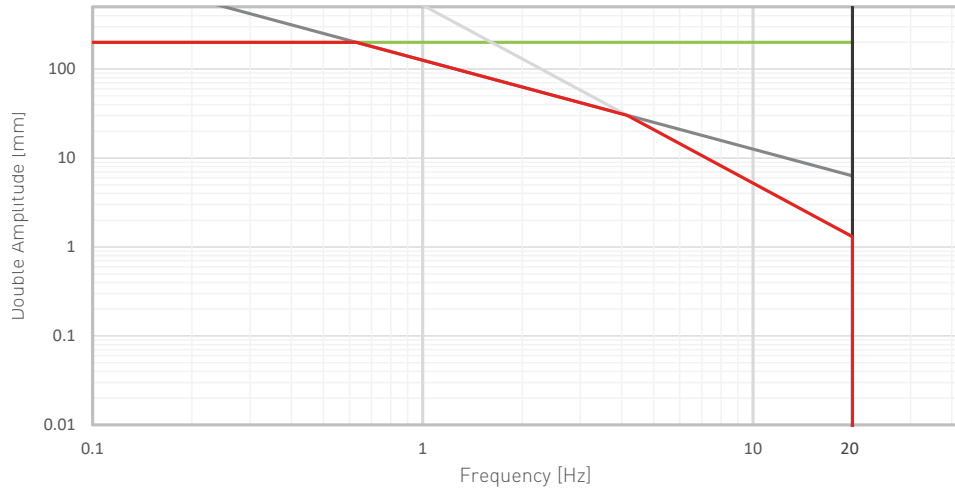

Performance chart - EA050-7/40/12A-N16/1.85-200

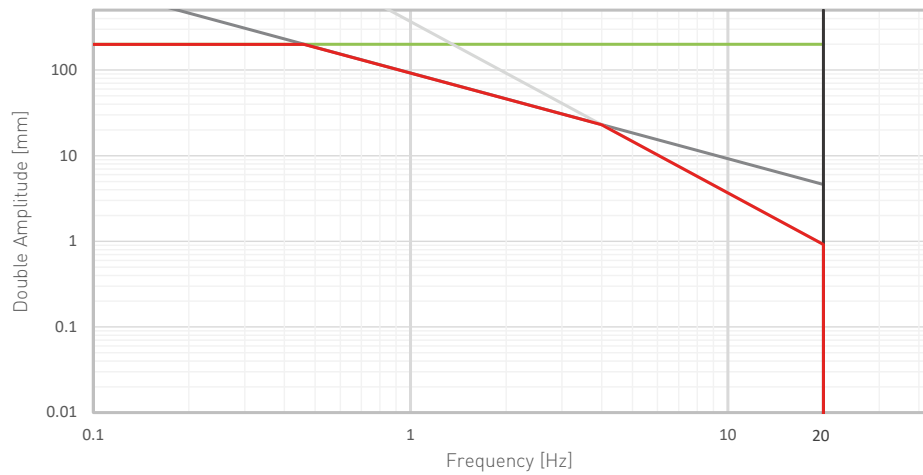

Performance chart - EA050-7/40/12A-N16/1.54-200

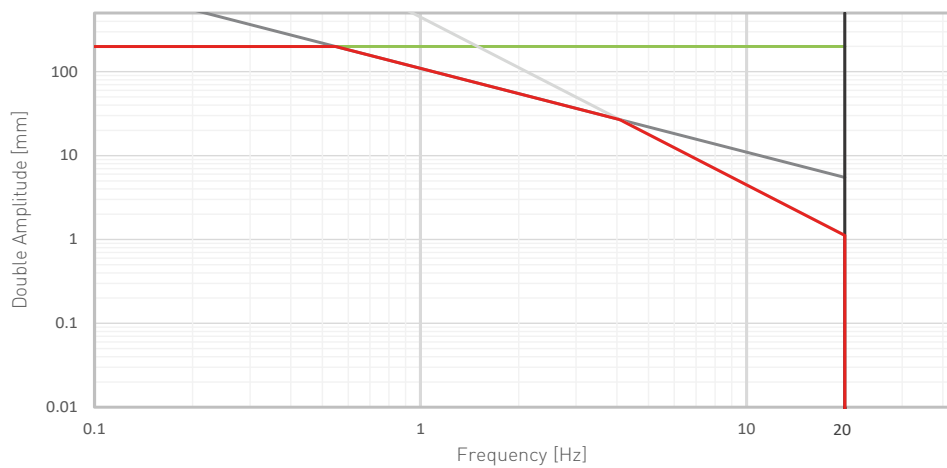

Stroke Limit Speed limit Acceleration limit Frequency Limit Total Performance

Performance chart - EA050-7F/40/24A-B10/2.29-200

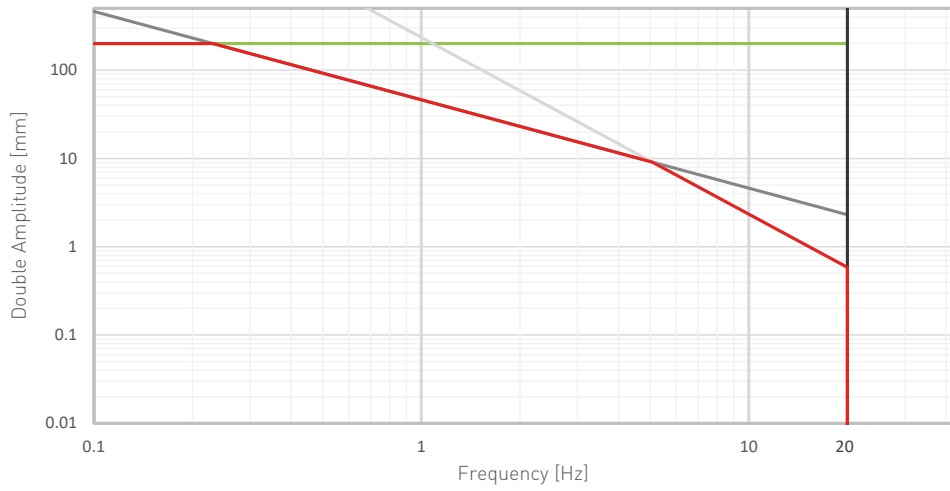

Performance chart - EA050-7F/40/24A-B20/1.41-200

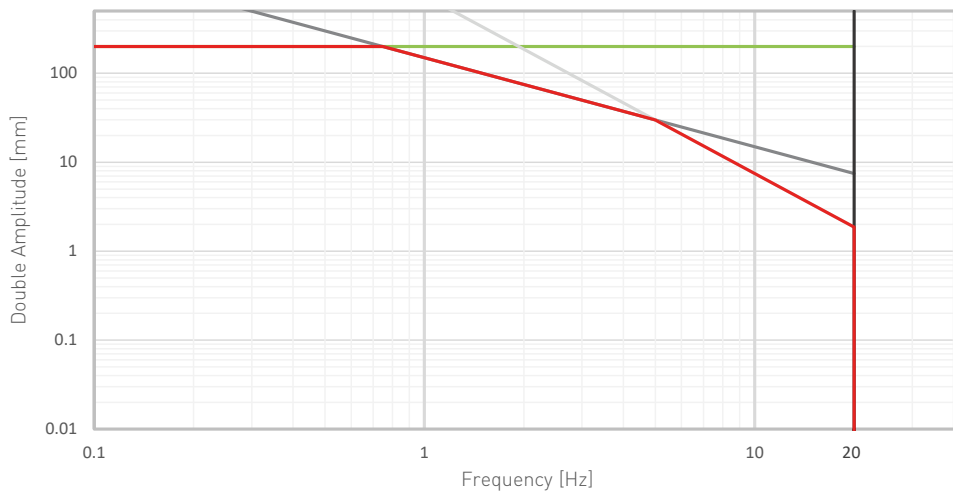

Performance chart - EA050-7F/40/24A-N16/1.06-200

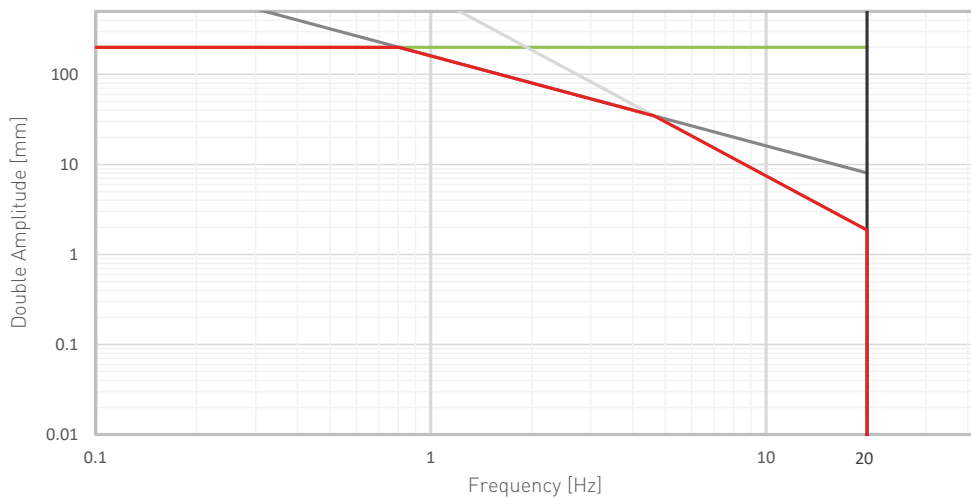

— Stroke Limit — Speed limit — Acceleration limit — Frequency Limit — Total Performance

Performance chart - EA050-7F/40/24A-N16/1.41-200

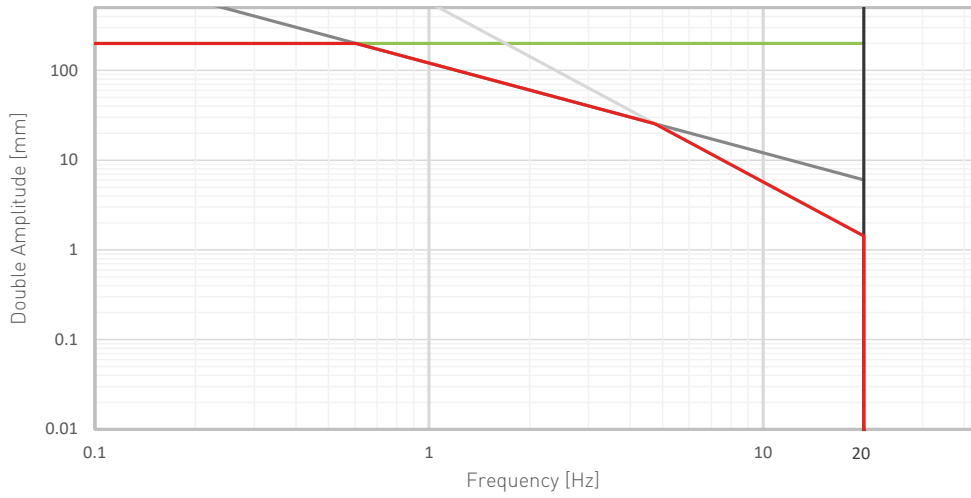

Performance chart - EA050-7F/40/24A-N16/1.47-200

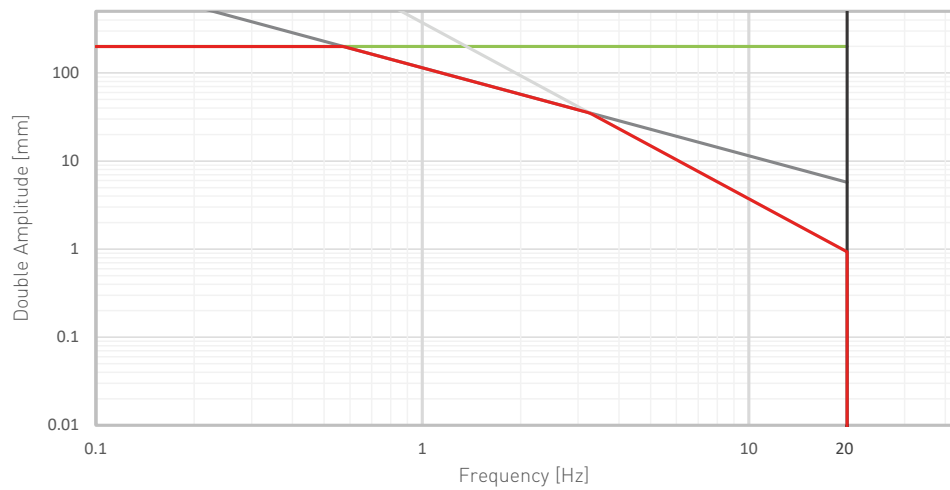

— Stroke Limit — Speed limit — Acceleration limit — Frequency Limit — Total Performance

Performance chart - EA050-7F/40/24A-N16/1.78-200

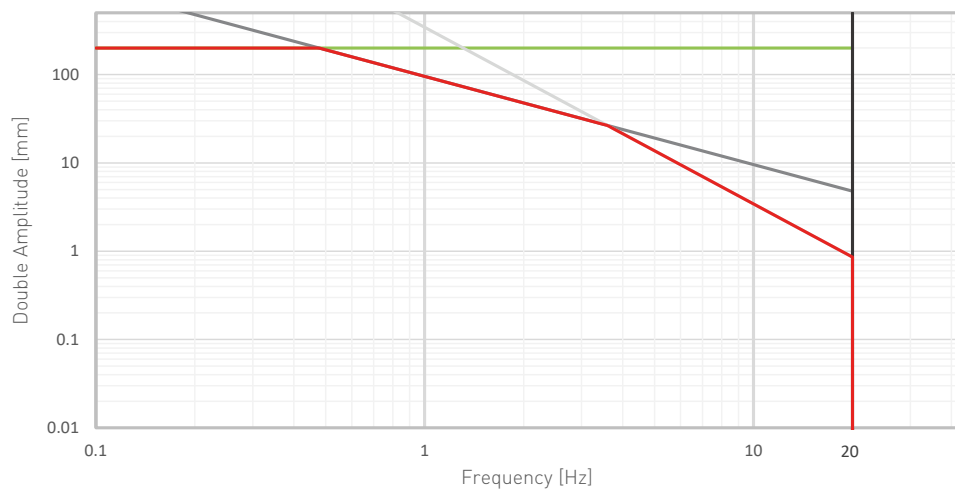

Stroke Limit Speed limit Acceleration limit Frequency Limit Total Performance

Performance chart - EA050-7F/40/24A-N16/2.29-200

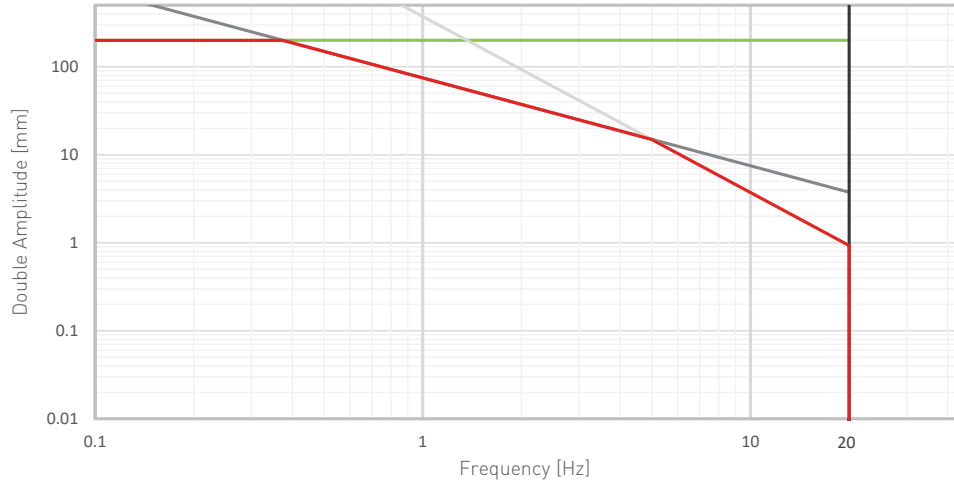

Performance Charts with Torque and Side Force / Tabelle Prestazioni con Carico Torsionale e Laterale*

Permissible side load for a given torque
EA050 - stroke 200 mm

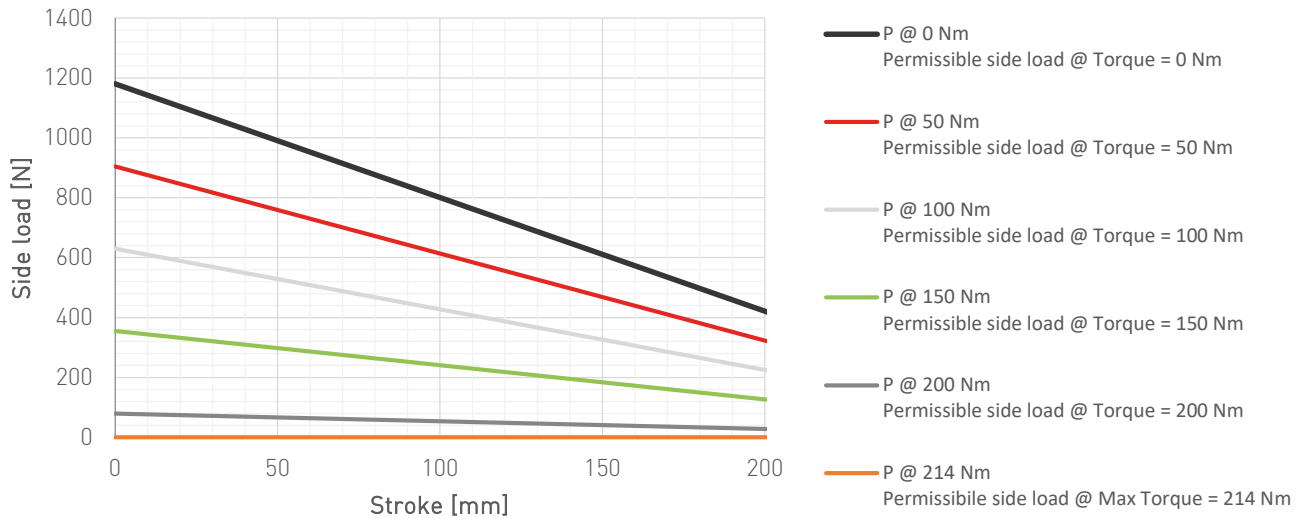

Permissible torque for a given side load
EA050 - stroke 200 mm

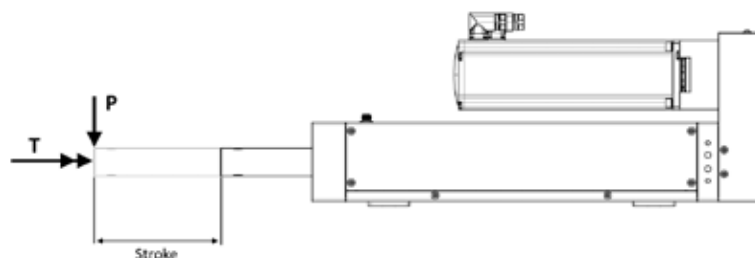
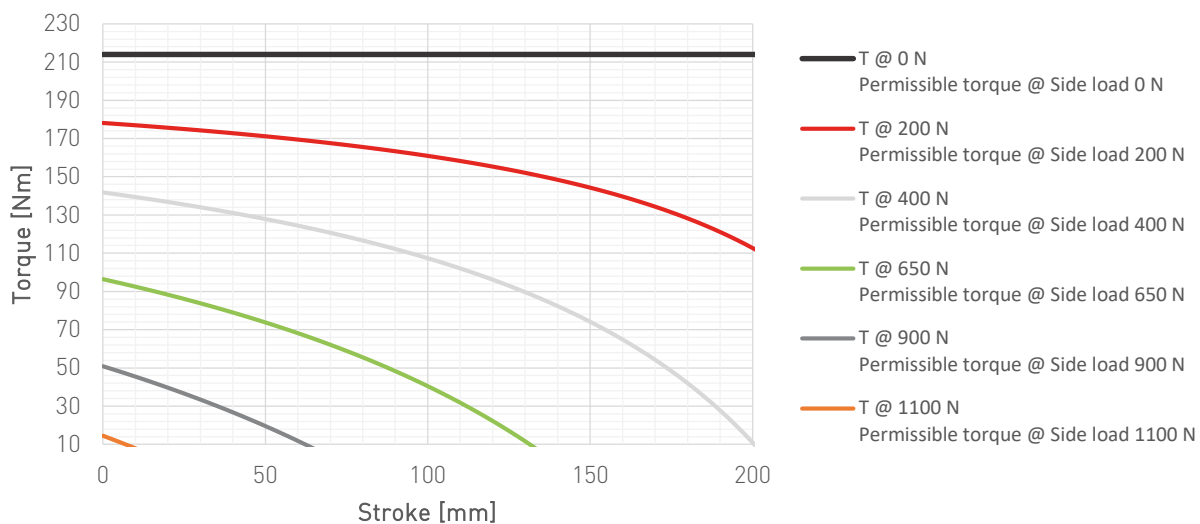

* These tables are intended for an indicative sizing. The final sizing will be provided by STEP Lab based on the request. /
Queste tabelle sono da usare per un dimensionamento indicativo. Il dimensionamento finale verrà fornito da STEP Lab in base alla richiesta.

EA100

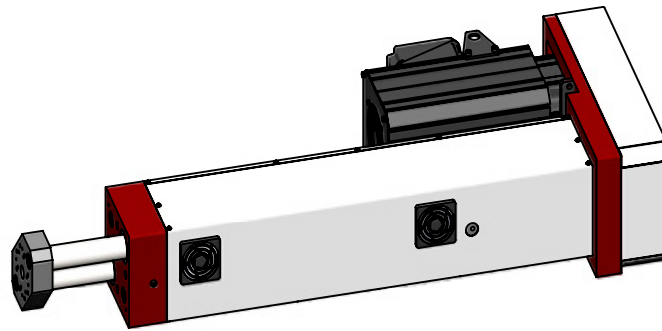
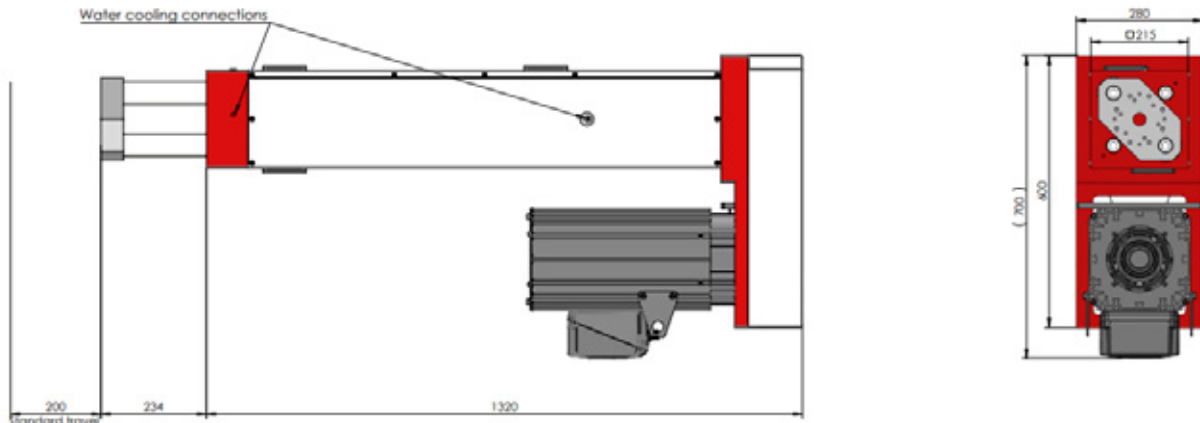

Main Features*

- + Maximum Dynamic Force 100 kN
- + Maximum Static Force 139 kN

Configuration and Codes / Configurazioni e Codici

	Code	Static Force (N)	Dynamic Force (N)	Acceleration (g)	Max. Speed (mm/s)	Standard Stroke (mm)
EA100	EA100-10F/10/45A-N40/1.67-200	29700	41100	1.95	800	200
	EA100-10F/10/45A-N40/2.22-200	39800	48800	1.25	600	
	EA100-10F/10/48A-N16/1-200	44700	61600	1.00	535	
	EA100-10F/10/48A-N16/1.67-200	74600	100000	0.73	320	
	EA100-10F/10/45A-N16/2.22-200	99400	100000	0.49	240	
	EA100-10F/10/48A-N16/3.11-200	139200**	100000	0.26	170	

* Other values available under request. / Altri valori disponibili su richiesta.

**Configuration for heavy loads with low dynamic. Configuration not available with swivel joint on the top.

| Configurazione dedicata ad alti carichi a bassa dinamica. Configurazione senza possibilità di utilizzo di giunto snodato lato motori

Stroke Limit Speed limit Acceleration limit Frequency Limit Total Performance

Performance chart - EA100-10F/10/45A-N40/1.67-200

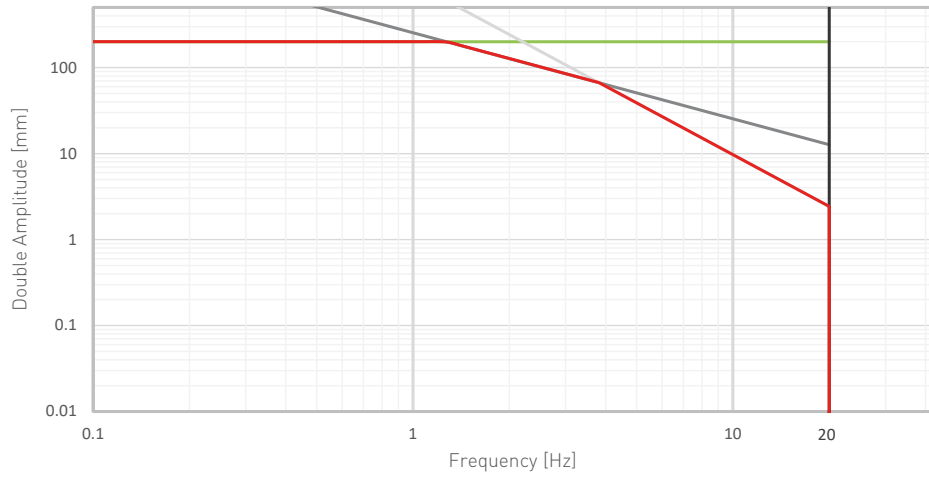

Performance chart - EA100-10F/10/45A-N40/2,22-200

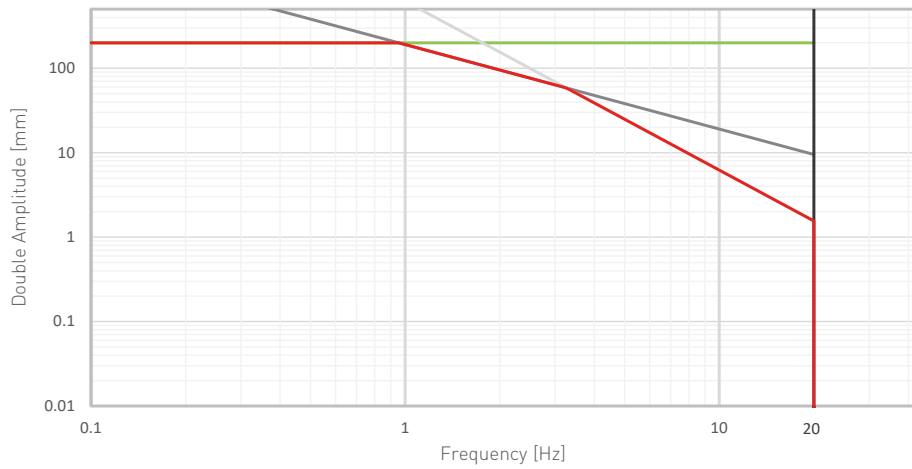

Performance chart - EA100-10F/10/48A-N16/1-200

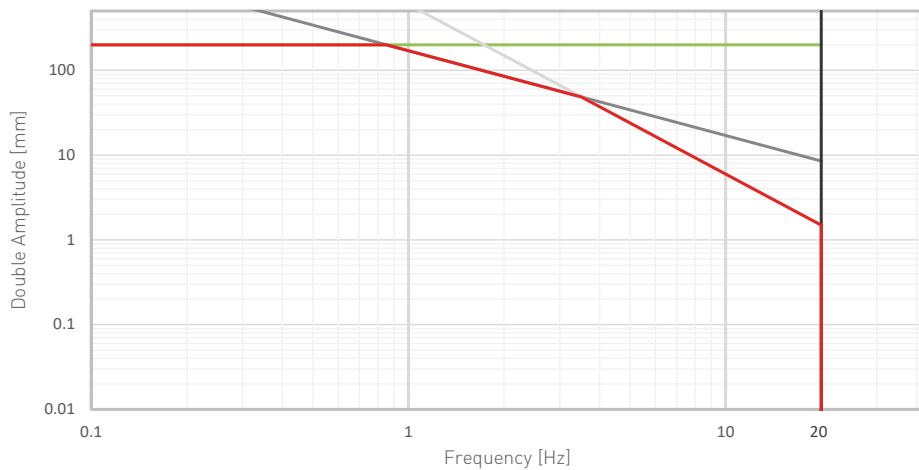

— Stroke Limit — Speed limit — Acceleration limit — Frequency Limit — Total Performance

Performance chart - EA100-10F/13/48A-N16/3-200

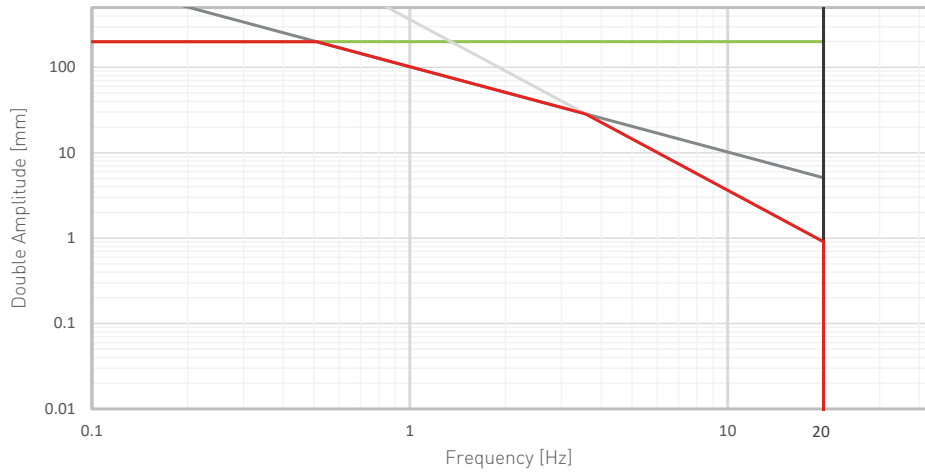

Performance chart - EA100-10F/10/45A-N16/2,22-200

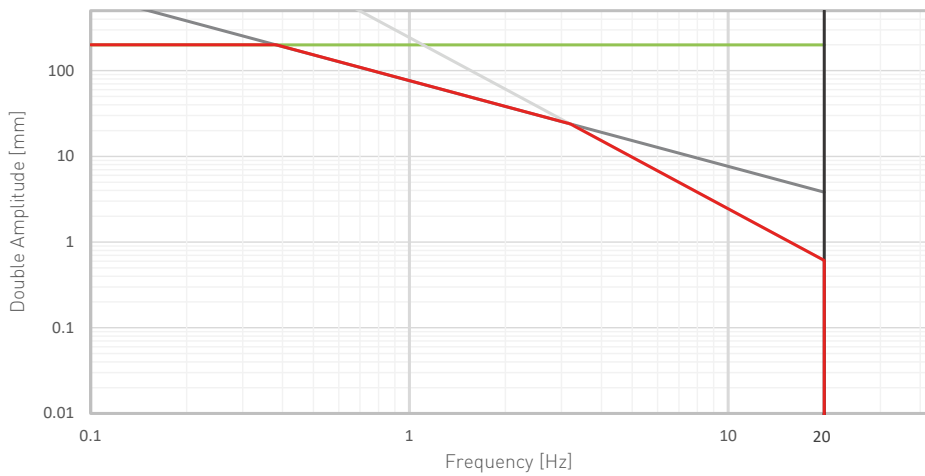

Performance chart - EA100-10F/10/48A-N16/3,11-200

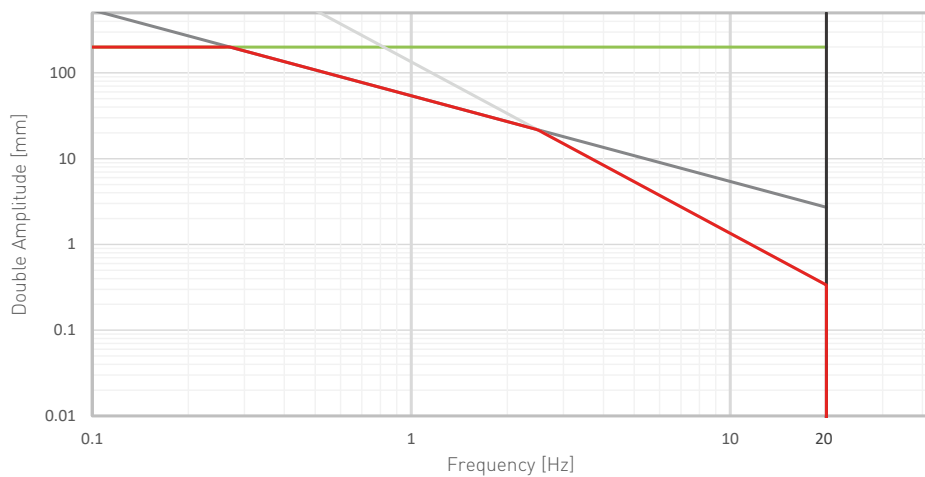

Performance Charts with Torque and Side Force / Tabelle Prestazioni con Carico Torsionale e Laterale*

Permissible side load for a given torque
EA100 - stroke 200 mm

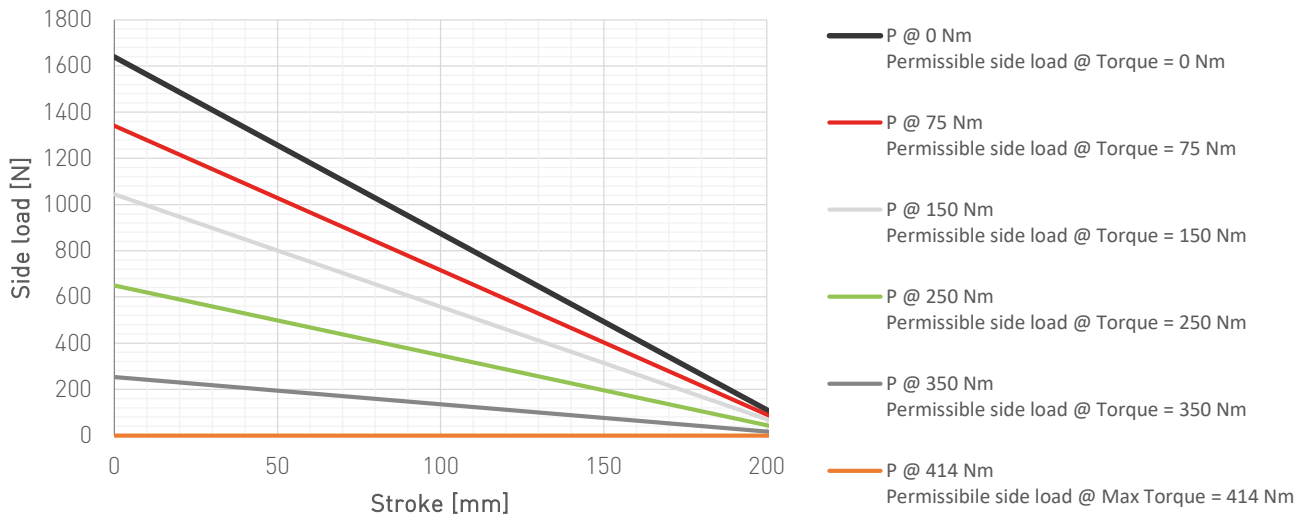

Permissible torque for a given side load
EA100 - stroke 200 mm

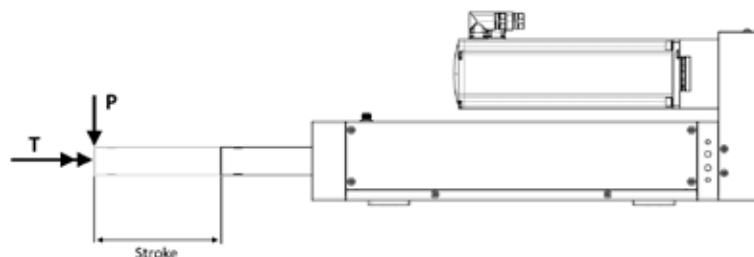
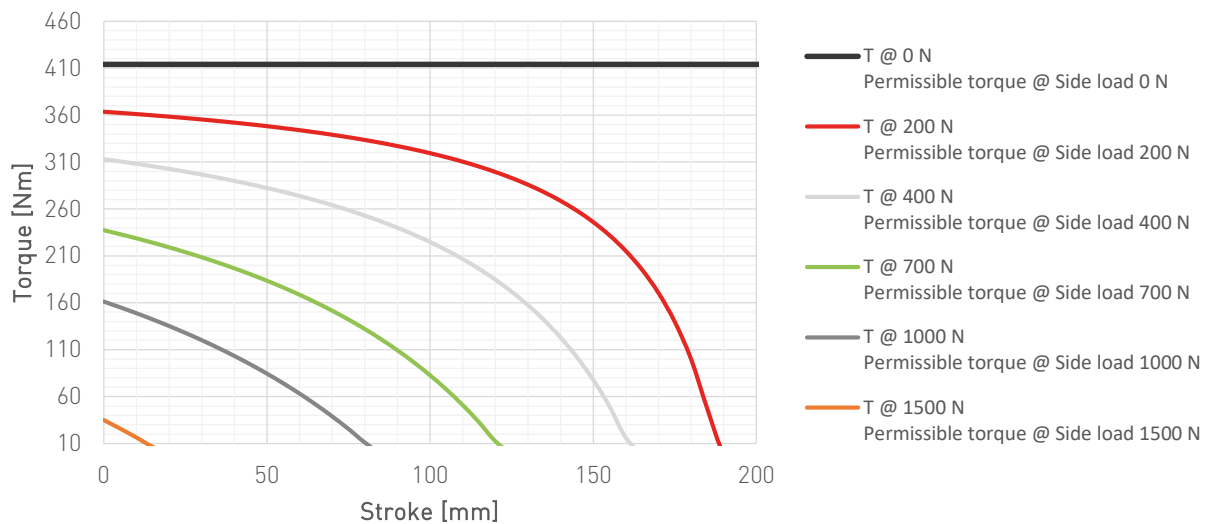

* These tables are intended for an indicative sizing. The final sizing will be provided by STEP Lab based on the request. /
Queste tabelle sono da usare per un dimensionamento indicativo. Il dimensionamento finale verrà fornito da STEP Lab in base alla richiesta.

EA200

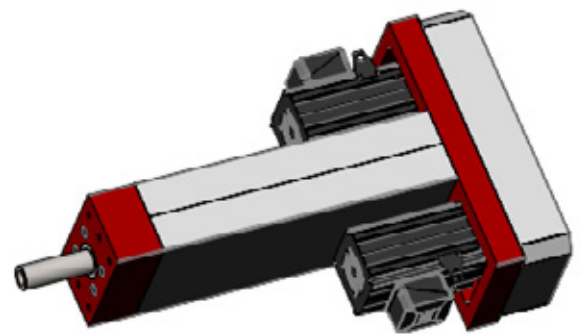
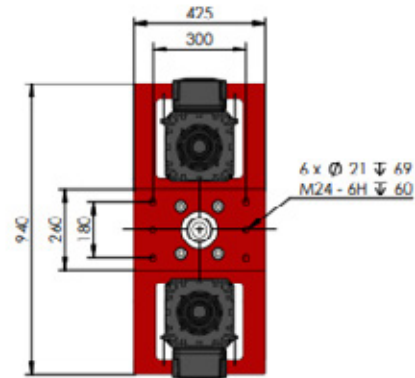
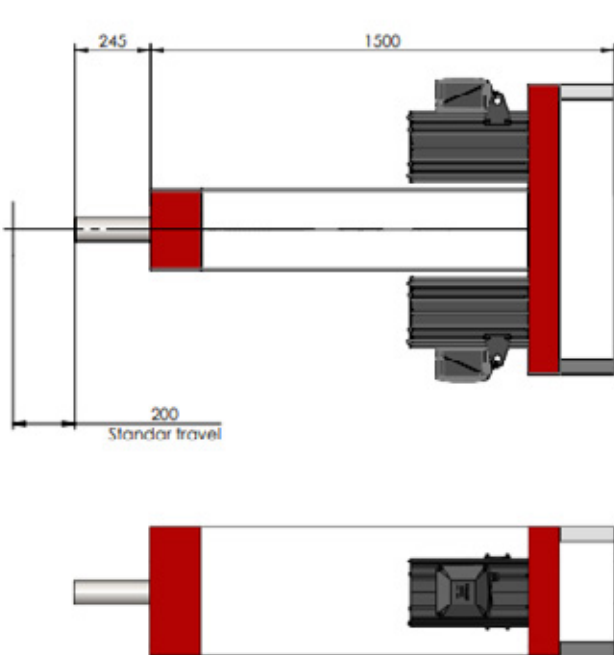

Main Features*

- + Maximum Dynamic Force 200 kN
- + Maximum Static Force 278 kN

Configuration and Codes / Configurazioni e Codici

	Code	Static Force (N)	Dynamic Fore (N)	Acceleration (g)	Max. Speed (mm/s)	Standard Stroke (mm)
EA200	EA200-210F/10/45A-N16/1-200	89500	123200	1.10	535	200
	EA200-210F/10/45A-N16/1.67-200	149200	200000	0.73	320	
	EA200-210F/10/45A-N16/3.11-200	278400**	200000	0.26	170	

* Other cvalues aviable under request. / Altri valori disponibili su richiesta.

**Configuration for heavy loads with low dynamic. Configuration not available with swivel joint on the top.

| Configurazione dedicata ad alti carichi a bassa dinamica. Configurazione senza possibilità di utilizzo di giunto snodato lato motori

— Stroke Limit — Speed limit — Acceleration limit — Frequency Limit — Total Performance

Performance chart - EA200-210F/10/45A-N16/1-200

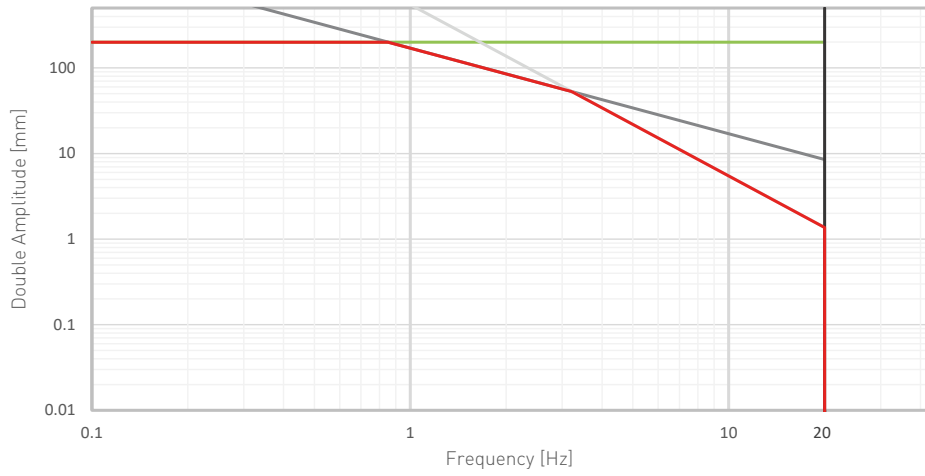

Performance chart - EA200-210F/10/45A-N16/1.67-200

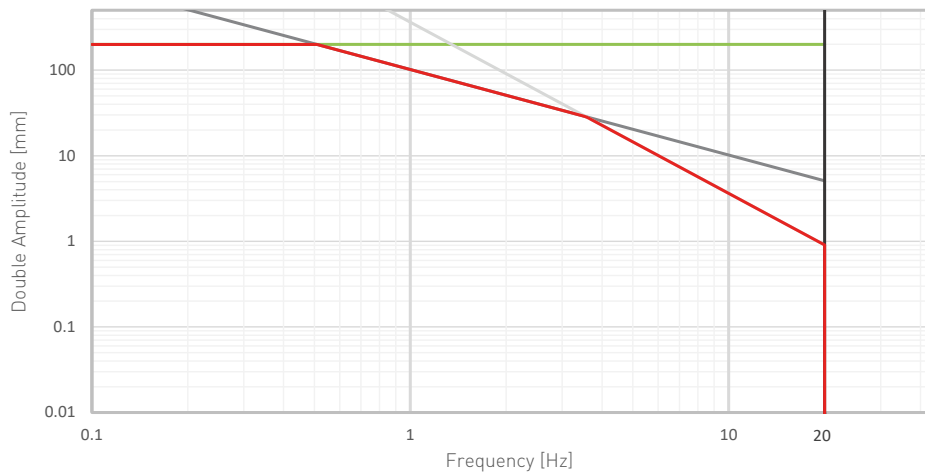

Performance chart - EA200-210F/10/45A-N16/3.11-200

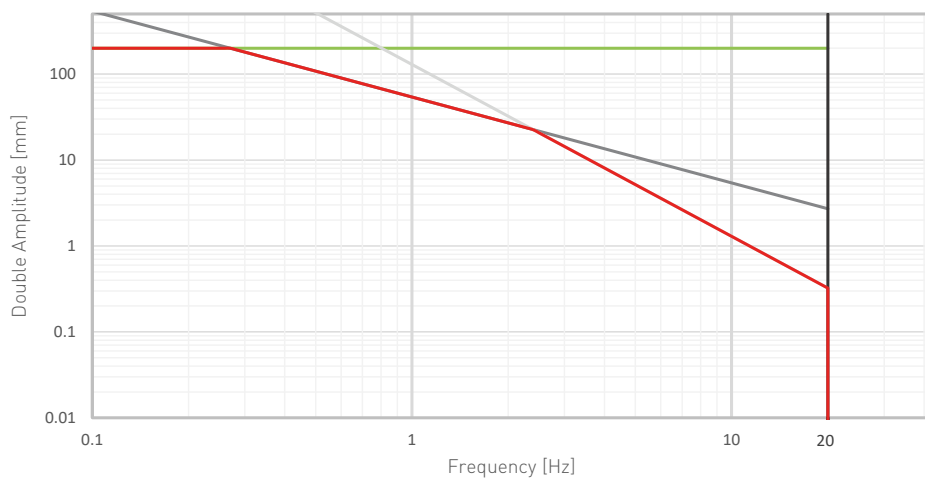

Performance Charts with Torque and Side Force /
Tabelle Prestazioni con Carico Torsionale e Laterale*

Permissible side load for a given torque
EA200 - stroke 200 mm

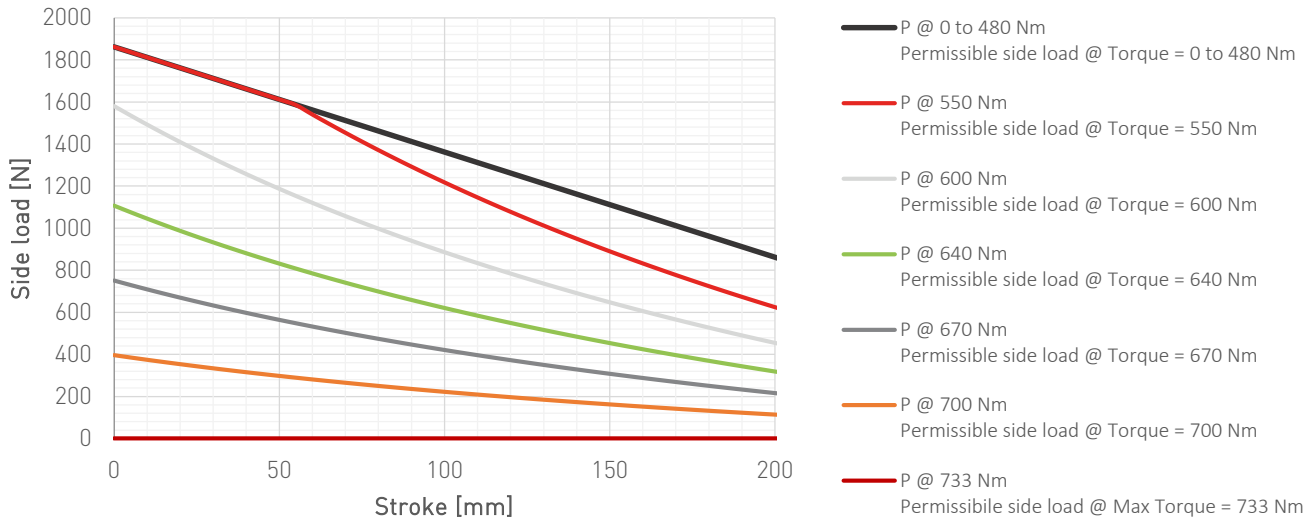

Permissible torque for a given side load
EA200 - stroke 200 mm

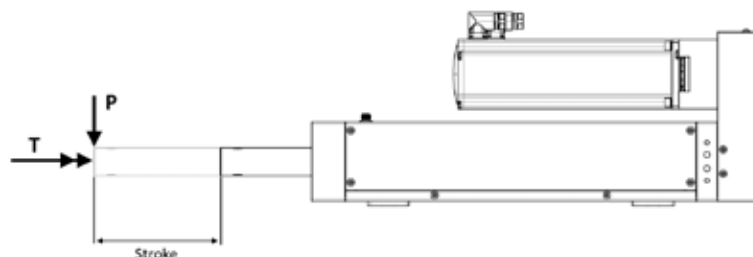
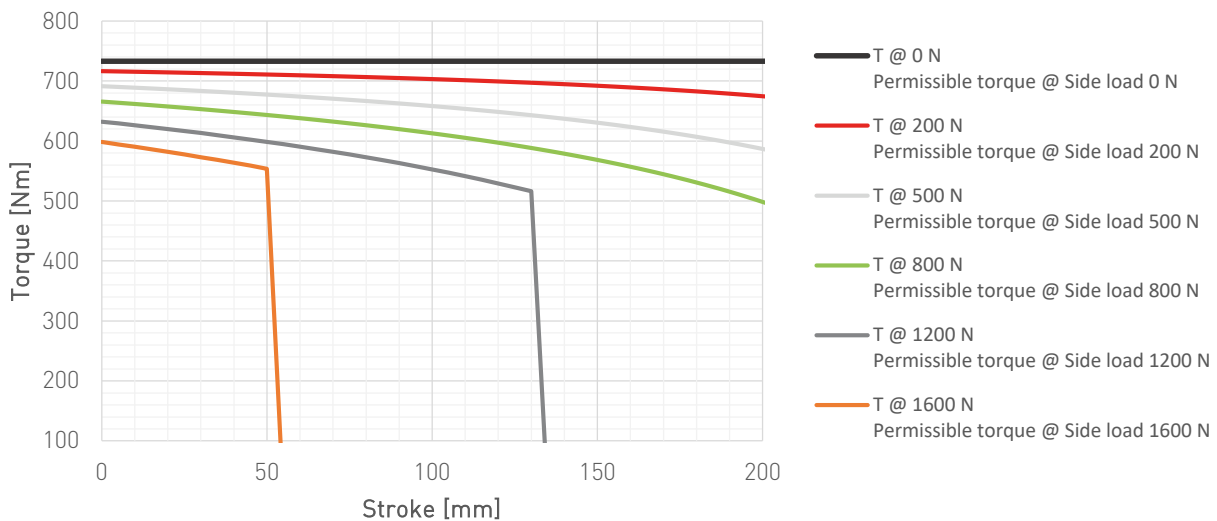

* These tables are intended for an indicative sizing. The final sizing will be provided by STEP Lab based on the request. /
Queste tabelle sono da usare per un dimensionamento indicativo. Il dimensionamento finale verrà fornito da STEP Lab in base alla richiesta.

Bi-axial Variant: Torsional Actuator / Variante Bi-assiale: Attuatore Torsionale

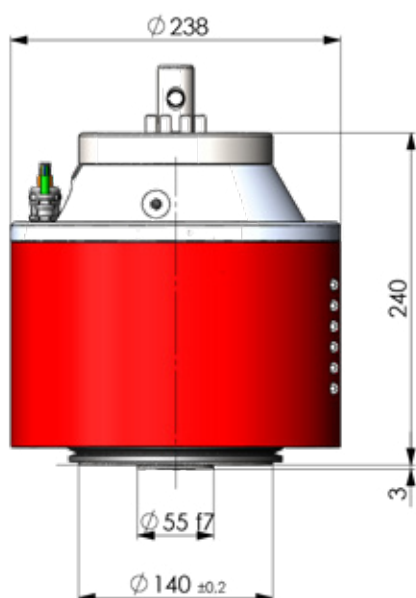

BV140 - Dimensions

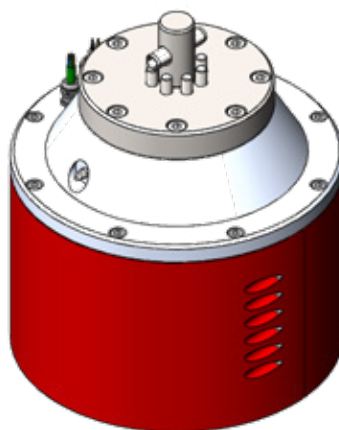

BV140



EA015 with BV140 variant

General description

Technical solutions for electromechanical axis and for axis based on linear motors.

Descrizione generale

Soluzioni tecniche per assi elettromeccanici e assi basati su motori lineari.

	BV020	BV050	BV090	BV140	BV200
Massima coppia statica <i>Max. Static Torque [Nm]</i>	13.5	35.0	65.0	100.0	140.0
Massima coppia dinamica <i>Max. Dynamic Torque [Nm]</i>	20.0	50.0	90.0	140.0	200.0
Massima velocità di prova <i>Max. Test Speed [rpm]</i>	300	300	300	300	250
Numero massimo di rivoluzioni <i>Max. Number of Revolutions</i>	Illimitato <i>Unlimited</i>	Illimitato <i>Unlimited</i>	Illimitato <i>Unlimited</i>	Illimitato <i>Unlimited</i>	Illimitato <i>Unlimited</i>
Encoder rotativo assoluto <i>Rotational Absolute Encoder</i>	Integrato <i>Integrated</i>	Integrato <i>Integrated</i>	Integrato <i>Integrated</i>	Integrato <i>Integrated</i>	Integrato <i>Integrated</i>
Compatibile con attuatori <i>Compatible with Actuators</i>	da EA05 in su da UD02 in su <i>EA05 and greater UD02 and greater</i>	da EA015 in su da UD04 in su <i>EA015 and greater UD04 and greater</i>	da EA015 in su da UD04 in su <i>EA015 and greater UD04 and greater</i>	da EA015 in su da UD08 in su <i>EA015 and greater UD08 and greater</i>	da EA015 in su da UD08 in su <i>EA015 and greater UD08 and greater</i>

All the solutions is comprehensive of biaxial load cell./Tutte le soluzioni sono comprensive di cella di carico biassiale

* Greater value upon request / Valori maggiori su richiesta

➤ Structure Types / Tipi di struttura

➤ Configurations of ST05 Frames / Configurazioni delle Strutture ST05

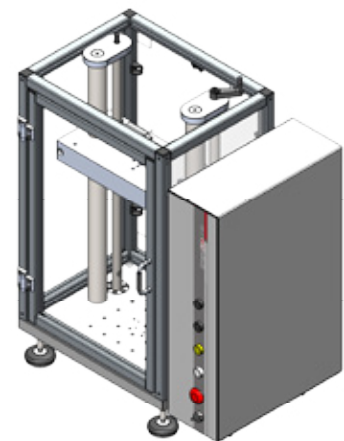
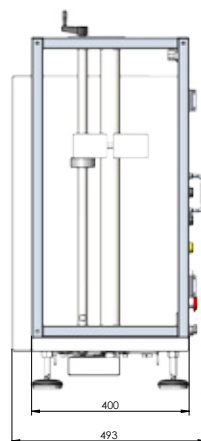
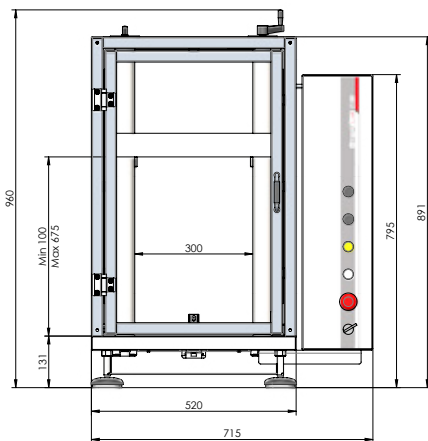
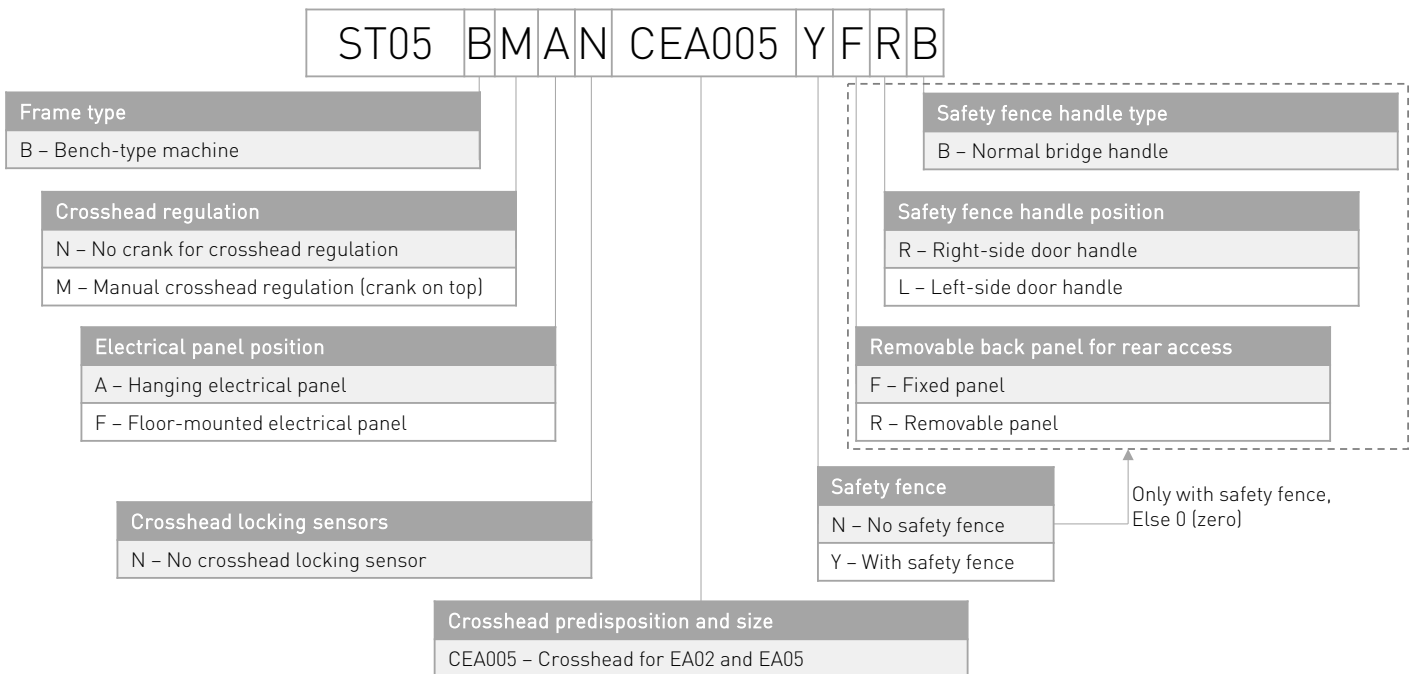

Example of ST05 Manual Bench-type Frame: ST05 BMAN CEA005 YFRB

Structure	Actuator
ST05	EA02 EA05
ST015 (89 mm crosshead th.) *	EA02 EA05 EA015 EA050
ST015 (150 mm crosshead th.) **	EA015 EA050 EA100
ST100	EA050 EA100 EA200

* Suggested for loads up to 20 kN / *Suggerito per carichi fino a 20 kN*

** Suggested for loads over 20 kN / *Suggerito per carichi oltre 20 kN*

Accessories / Accessori

Item	Fmax [kN]
Load cell / <i>Cella di carico</i> ¹	0,1
	0,5
	1
	2,5
	5
	10
	25
	50
	100
	200
	300

¹ The standard accuracy class is 1 (ISO 376). The accuracy class 05 and 00 are available upon request.

¹ *L'accuratezza delle celle di carico fornite è 1 (ISO 376). A richiesta sono disponibili celle di carico con accuratezza 05 e 00.*

Item

Control for two or more synchronized electro-mechanical actuator
Controllo per due o più assi sincronizzati

Climatic temperature chambers integrated on the structure and managed by Test Center
Camere climatiche integrate nella struttura e gestite da Test Center

Remote control
Controllo a distanza

Wedge grips for tests on plane specimen
Griffe a cuneo per test su provini piani

Wedge grips for tests on cylindrical specimen
Griffe a cuneo per test su provini cilindrici

Mechanical customized grips for materials and products mono-axial testing
Afferraggi personalizzati per test monoassiali di materiali e prodotti

Mechanical customized grips for materials and products multi-axial testing
Afferraggi personalizzati per test multiassiali di materiali e prodotti



STEP Lab

Via Castellana 199, 31023 Resana - Treviso - ITALY

Tel.: +39 0423 1999 391

info@step-lab.com

www.step-lab.com

